



CONCRETE ACCESSORIES

Sika® Westec®

BARRIER TECHNOLOGIES

WATERSTOPS FOR INDUSTRIAL APPLICATIONS

BUILDING TRUST



QUALITY PRODUCTS FOR SECONDARY CONTAINMENT & OPTIMUM PERFORMANCE

SUPERIOR SERVICE

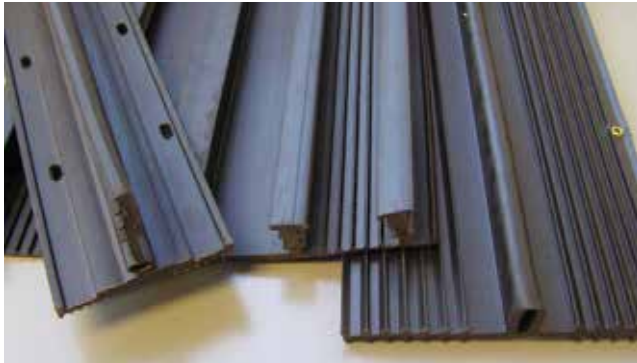

Sika technical engineers are available for design review, chemical testing data, material takeoff and shop drawing assistance.

Industrial applications often have harsh chemical environments in which a traditional flexible PVC waterstop may not be suitable. Sika's Westec® Barrier Technologies specialize in waterstop applications for these unique conditions with a wide range of both traditional and specialty profiles specifically designed for industrial applications.

CHEMICAL RESISTANCE: GENERAL GUIDELINES

Chemical resistance recommendations are based on short term, secondary containment applications. Typical testing is performed according to ASTM D-471 "Standard Test Method for Rubber Property-Effect of Liquids" with 166-hour (7 day) immersion. Performance data has been collected from a variety of sources including industry reference data, third-party and in-house testing. Consult a Sika Technical Sales Representative for application specific chemical data or further testing.

APPLICATION AREAS

- Ethanol / Biodiesel Plants
- Petrochemical Manufacturing
- Refineries
- Pulp and Paper Mills
- Land, Air and Seaports
- Fuel Storage / Tank Farms
- Pipelines
- Pharmaceutical Plants

CHEMICAL EXPOSURE	Temperature	TPE-R	PE	Stainless Steel 316	PVC
Rating Key: A = Excellent B = Good C = Conditional X = Do not use					
Ammonia, Anhydrous	23°C (73.4°F)	A	B	A	A
*Antifreeze	100°C (212°F)	A	B	A	A
(50% Ethylene Glycol/50% Water)	125°C (257°F)	B		A	
ASTM Oil #2	100°C (212°F)	B		A	X
Benzene	23°C (73.4°F)	B	B	A	X
Carbon Tetrachloride	23°C (73.4°F)	X	X	B	X
Chlorine (Wet/Dry)	23°C (73.4°F)	A/A	C/C	A/X	X/X
Creosote	23°C (73.4°F)	A		A	X
Cyclohexane	23°C (73.4°F)	X	X	A	X
Diesel Fuel	23°C (73.4°F)	B	B	A	X
Ethanol	23°C (73.4°F)	A	A	A	X
Hydraulic Fluid	23°C (73.4°F)	A	B	A	X
Hydrogen Peroxide	23°C (73.4°F)	A	B	B	A
Isopropyl Alcohols	23°C (73.4°F)	A	A	A	A
Jet Fuel - JP8	23°C (73.4°F)	B	B	A	C
Kerosene	23°C (73.4°F)	B	C	A	C
Methyl Ethyl Ketone	23°C (73.4°F)	B	B	A	X
Nitric Acid- 70%	23°C (73.4°F)	B	X	A	X
Oil, Mineral	23°C (73.4°F)	A	B	A	B/C
Sodium Hydroxide 80% Solution	23°C (73.4°F)	A	C	X	A
Sodium Hypochlorite	23°C (73.4°F)	A	B	B	A
Styrene	23°C (73.4°F)	B	B	A	X
Sulfuric Acid 98%	23°C (73.4°F)	B	C	X	X
Tetrahydrofuran	23°C (73.4°F)	B	X	A	X
Toluene	23°C (73.4°F)	B	B	A	X
Trichloroethylene	23°C (73.4°F)	X	X	A	X
DI Water pH 11	23°C (73.4°F)	A	B	A	A
Xylene	23°C (73.4°F)	B	B	A	X

MATERIAL CHOICES FOR OPTIMUM PERFORMANCE

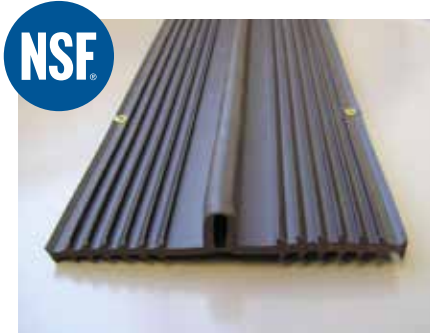

Envirostop® TPE-R

Thermoplastic Elastomeric Rubber is a fully vulcanized blend of EPDM and Polypropylene, also called a Thermoplastic Vulcanizate or TPV. This gives the waterstop the flexibility and sealing properties of a rubber seal, but allows for heat welding and processing like a plastic. In addition to the favorable physical properties, TPE-R also offers an excellent resistance to a wide range of chemicals. ASTM tests (D-471) show good resistance to oils, fuels, acids, bases and numerous solvents.



Envirostop® TPE-R
Westec® Envirostop® TPE-R waterstop is certified to NSF/ANSI Standard 61 for drinking water applications. The standard establishes minimum health effects requirements for the chemical contaminants and impurities that may be indirectly imparted to drinking water. Although more commonly known for its use in chemical containment applications, TPE-R waterstop is now widely used for ozone contact structures in the water treatment industry. Envirostop® TPE-R waterstop can be specified for any drinking water containment structure where this certification is required for joint sealing materials.

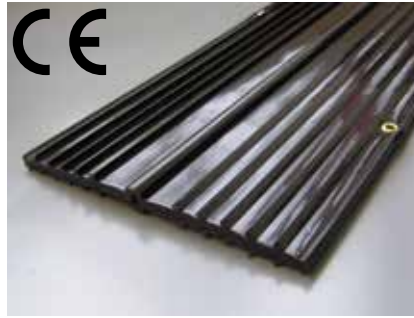

PE POLYETHYLENE

Polyethylene (VLDPE) is more plastic-like, having increased elastic modulus and hardness than TPE-R. PE also has greater resistance in some applications, and is particularly effective for hydrocarbons such as Benzene, Toluene and Xylene. After exposure (1-4 weeks) to such and subsequent drying, PE waterstop was found to return nearly to its original physical properties.



Westec® PE 050 and 631 waterstop profiles are the first to receive the European Technical Approval for watersealing bands and have been approved for CE marking in the European Union, ETA-04/0044.



GROMMETS

TPE-R and PE 6" and 9" waterstops are pre-punched in the outermost rib with brass grommets providing convenient points on 12" centers to wire the waterstop to reinforcement. Properly securing the waterstop is critical to ensure good consolidation around the ribs and a liquid-tight seal.



SS (STAINLESS STEEL)

Stainless steel is for high temperature environments that exceed 121°C (250°F) or the most severe chemical applications. Sika offers 316 low carbon stainless steel waterstops. However, many applications that have traditionally used SS waterstop can be served with TPE-R, including ozone contact structures.



SPLICING AND FABRICATIONS

Sika® Greenstreak® PVC welding equipment and techniques can be used for Westec® TPE-R and PE waterstops, requiring only a higher temperature set at 210°C (410°F). Sika recommends factory-fabricated joints at all intersections and direction changes. They offer a quick and economical alternative to cutting and splicing these critical junctions in the field. Contact a Sika Technical Sales Representative to arrange for a material takeoff and custom shop drawings. Fabrications are available for TPE-R, PE and SS.

PROFILES

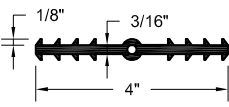
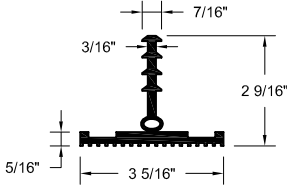
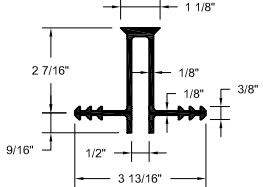
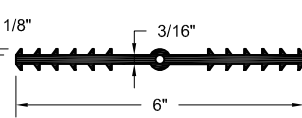
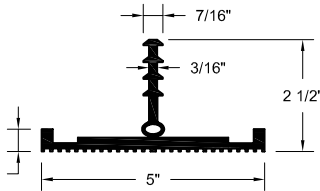
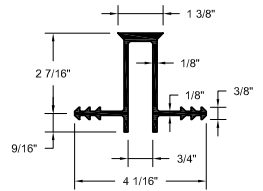
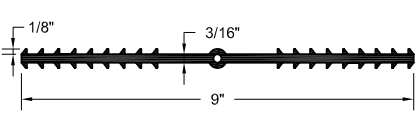
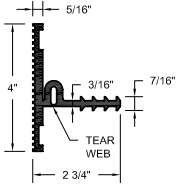
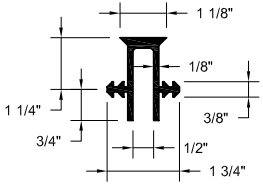
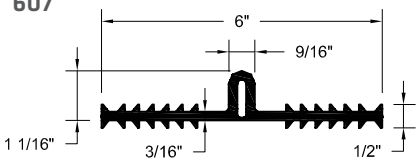
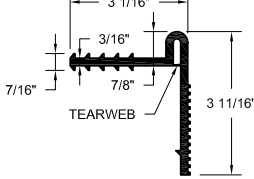
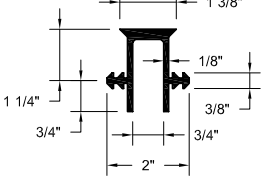
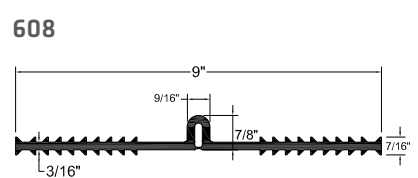
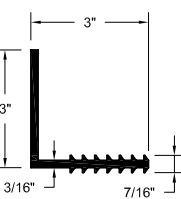
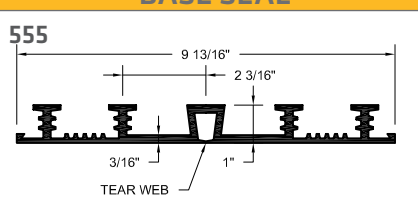
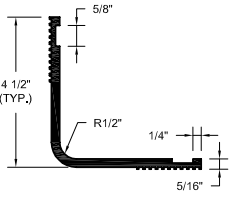
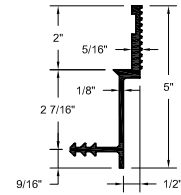
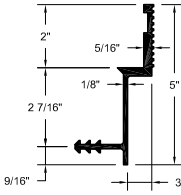

Envirostop® TPE-R PROFILES: STANDARD, RETROFIT AND EB CAP

RIBBED CENTERBULB	RETROFIT	EB CAP	
<p>618</p> <p>3/16" ID & 7/16" OD</p> 	<p>629</p> 	<p>637</p> 	
<p>619</p> <p>3/16" ID & 7/16" OD</p> 	<p>630</p> 	<p>638</p> 	
<p>620</p> <p>3/16" ID & 7/16" OD</p> 	<p>686</p> 	<p>634</p> 	
RIBBED TEAR WEB			
<p>607</p> 	<p>697</p> 	<p>639</p> 	
<p>608</p> 	<p>694</p> 	EB CAP RETROFIT	
<th colspan="3" data-bbox="164 1654 1459 1696">BASE SEAL</th>	BASE SEAL		
<p>555</p> 	<p>691</p> 	<p>687</p> 	
	<p>688</p> 		

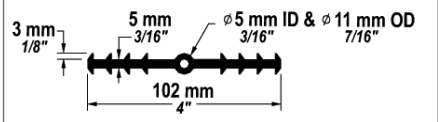
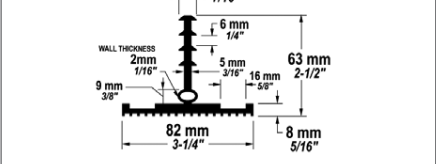
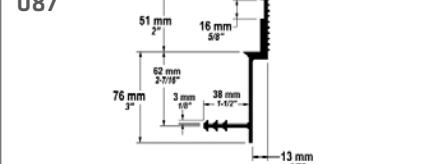
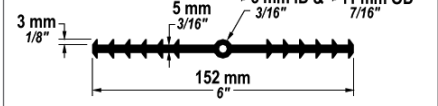
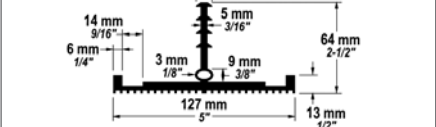
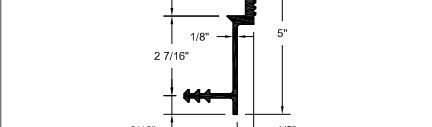
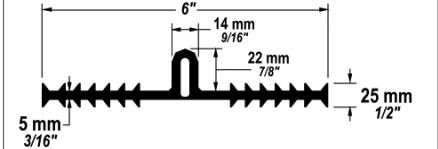
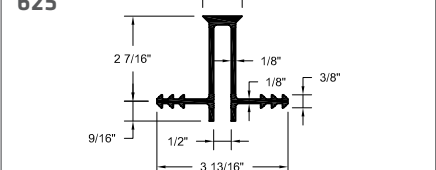
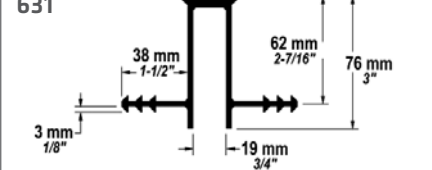
PE PROFILES: STANDARD, RETROFIT AND EB CAP

<p>039</p>  <p>3 mm 1/8"</p> <p>5 mm 3/16"</p> <p>102 mm 4"</p> <p>5 mm ID & 11 mm OD 3/16" 7/16"</p>	<p>031</p>  <p>11 mm 7/16"</p> <p>6 mm 1/4"</p> <p>2 mm 1/16"</p> <p>9 mm 3/8"</p> <p>82 mm 3-1/4"</p> <p>5 mm 3/16"</p> <p>16 mm 5/8"</p> <p>63 mm 2-1/2"</p> <p>8 mm 5/16"</p> <p>WALL THICKNESS</p>	<p>EB CAP RETROFIT</p> <p>087</p>  <p>51 mm 2"</p> <p>16 mm 5/8"</p> <p>62 mm 2-3/16"</p> <p>76 mm 3"</p> <p>13 mm 1/2"</p> <p>38 mm 1-1/2"</p> <p>3 mm 1/8"</p>
<p>050</p>  <p>3 mm 1/8"</p> <p>5 mm 3/16"</p> <p>152 mm 6"</p> <p>5 mm ID & 11 mm OD 3/16" 7/16"</p>	<p>041</p>  <p>11 mm 7/16"</p> <p>5 mm 3/16"</p> <p>14 mm 9/16"</p> <p>6 mm 1/4"</p> <p>3 mm 1/8"</p> <p>9 mm 3/8"</p> <p>127 mm 5"</p> <p>64 mm 2-1/2"</p> <p>13 mm 1/2"</p>	<p>088</p>  <p>2"</p> <p>5/16"</p> <p>1/8"</p> <p>2 7/16"</p> <p>9/16"</p> <p>5"</p> <p>1/2"</p>
<p>040</p>  <p>152 mm 6"</p> <p>14 mm 9/16"</p> <p>22 mm 7/8"</p> <p>5 mm 3/16"</p> <p>25 mm 1 1/2"</p>	<p>EB CAP</p> <p>625</p>  <p>1 1/8"</p> <p>2 7/16"</p> <p>1/8"</p> <p>3 13/16"</p> <p>9/16"</p> <p>1/2"</p> <p>3/8"</p> <p>631</p>  <p>38 mm 1-1/2"</p> <p>62 mm 2-7/16"</p> <p>76 mm 3"</p> <p>19 mm 3/4"</p> <p>3 mm 1/8"</p>	

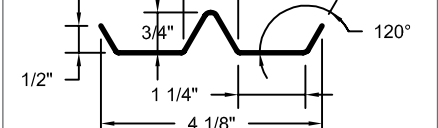
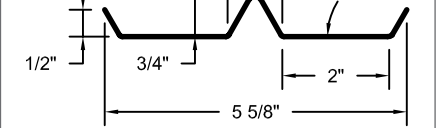
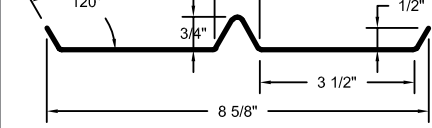
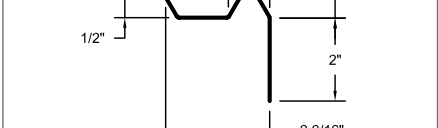
SS PROFILES (STAINLESS STEEL): STANDARD AND RETROFIT

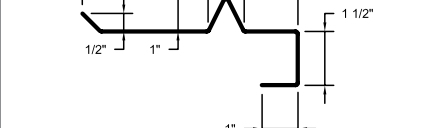
<p>498</p>  <p>1"</p> <p>3/4"</p> <p>1 1/4"</p> <p>4 1/8"</p> <p>120°</p> <p>1/2"</p>	<p>499</p>  <p>1"</p> <p>3/4"</p> <p>2"</p> <p>5 5/8"</p> <p>120°</p> <p>1/2"</p>	<p>496</p>  <p>1"</p> <p>3/4"</p> <p>3 1/2"</p> <p>8 5/8"</p> <p>120°</p> <p>1/2"</p>
<p>493</p>  <p>1"</p> <p>3/4"</p> <p>2"</p> <p>2 9/16"</p> <p>1/2"</p>	<p>494</p>  <p>1"</p> <p>3/4"</p> <p>2"</p> <p>3 5/16"</p> <p>1/2"</p>	<p>495</p>  <p>6"</p> <p>1"</p> <p>1"</p> <p>1 1/2"</p> <p>1/2"</p>

PATENTED EXPANSION BOARD CAP SEAL SYSTEM

CONSTRUCTION DETAILS FOR SPECIAL EB CAP DESIGNS

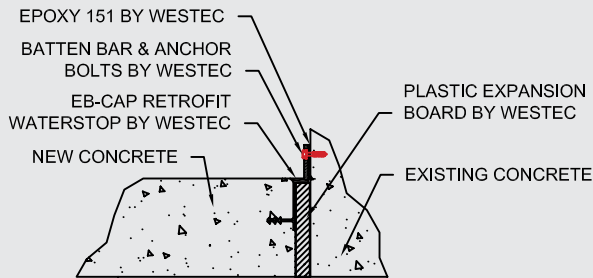
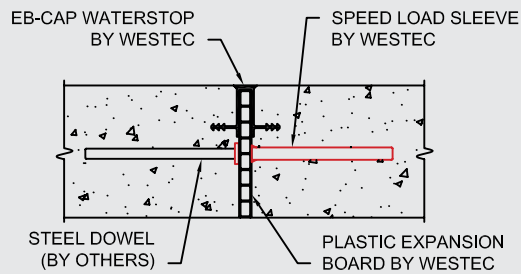

POLYBOARD

Westec® ¾" HDPE Polyboard is available for 6" and 8" paving applications. The polyboard is designed to work with the EB Cap and EB Cap retrofit profiles and serves as both expansion material and a forming system.

SPEED LOAD

Speed Load sleeves are an excellent addition to the Expansion Board cap seal and Polyboard. Speed Load sleeves align the steel load transfer dowels and are designed specifically for leave-in-place forming systems like the EB Cap System.



Please consult a Sika Technical Sales Representative for your specific project needs.

All Retrofit systems include stainless steel batten bars and tapcons. Westec® 151 Novolac Gel Epoxy creates a fluid tight and chemical resistant seal between the waterstop and existing concrete.



Patent # for EB Cap is 5,378,386

The EB Cap seal system is a complete concrete joint system designed and patented by Westec®. Easy to install, the EB Cap integrates the waterstop, forming system, expansion board, joint seal and load transfer units into a single structure. Just stake down the board, set your screed elevation and that's it. No stripping forms, no messy sealants, no problems!

INSTALLATION BENEFITS:

- No split formwork
- Fewer installation steps
- No poured-in-place sealant required
- No remobilization for saw cutting or sealant
- Convenient strip pouring possible with Speed Loads
- Lower labor and installation costs
- No joint finishing required

SELECTING THE RIGHT PROFILE

PHYSICAL PROPERTIES OF FINISHED WATERSTOP

PROPERTY	TEST METHOD	TPE-R	PE	*SS (STAINLESS STEEL)
Tensile Strength	ASTM D 638	2000 psi	2000 psi	75,000 psi
Elongation	ASTM D 638	450%	800%	40%
100% Modulus	ASTM D 638	1000 psi	4200 psi	
Brittle Temperature	ASTM D 746	-56°C (-70°F)		
Hardness	ASTM D 2240	85 Shore A	40 Shore D	95 max. Rockwell B
Yield Strength				25,000 psi

**SS Properties taken from ASTM A240, Table 2*

TPE-R and PE waterstops are available in a variety of sizes and profiles to meet the needs of various structures and applications.

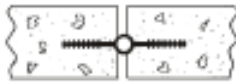

RIBBED WITH CENTERBULB is a very versatile waterstop and a standard for the concrete industry. The centerbulb of the waterstop accommodates vertical and horizontal movement equal to the inside diameter of the centerbulb. This waterstop can be used in control joints and expansion joints, vertical and horizontal applications. TPE-R and PE profiles are available.

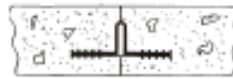

RIBBED WITH TEAR WEB is designed for larger joint movements. The thin web in the U-shaped centerbulb will tear during joint movement and allow for additional expansion or differential settlements. Some fabrications are limited. TPE-R and PE profiles are available.

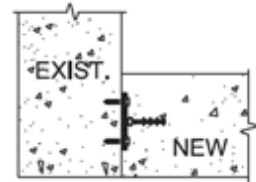

RETROFIT - Modern chemical plants and manufacturing facilities are constantly expanding, modifying existing areas for new technologies and products. Structural changes to the concrete areas create the potential for leaks between the new and existing concrete. Traditionally, adding a waterstop to these joints required saw cutting a groove several inches into the existing concrete and grouting in a waterstop. This method is time-consuming, labor-intensive and often requires cutting through the top layer of rebar in the existing concrete. Westec® offers multiple profiles for a variety of situations and applications. TPE-R, PE and SS Retrofit profiles are available.

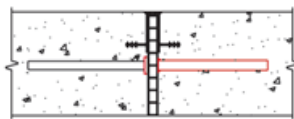

EB CAP - The patented Expansion Board Cap Seal system was designed to serve as both a waterstop and joint sealant. This unique design allows for one-step placement of your joint sealant and waterstop. No stripping, sawcutting or sealing is required. The result is an easy-to-install, maintenance-free joint. TPE-R and PE profiles are available.



BASE SEAL is designed for slab on grade joints or backfilled walls and eliminates difficult split forming details. This profile is difficult to join to other waterstops so may not be suitable for containment areas with standard waterstops in other joints. This profile is available only as TPE-R.

SIKA FULL RANGE SOLUTIONS FOR CONSTRUCTION:



WATERPROOFING



CONCRETE



REFURBISHMENT



SEALING AND BONDING



FLOORING



ROOFING

All sales of Sika products are subject to Sika's current Terms and Conditions of Sale available at usa.sika.com or by calling 800-325-9504. Prior to each use of any Sika product, the user must always read and follow the warnings and instructions on the product's most current Product Data Sheet, product label and Safety Data Sheet, which are available at usa.sika.com or by calling Technical Services at 800-325-9504. Nothing contained in any Sika materials relieves the user of the obligation to read and follow the warnings and instructions for each Sika product as set forth in the current Product Data Sheet, product label and Safety Data Sheet prior to product use.

The sale of all Sika products are subject to the following Limited Warranty:

LIMITED MATERIAL WARRANTY

SIKA warrants this product for one year from date of installation to be free from manufacturing defects and to meet the technical properties on the current Product Data Sheet if used as directed within shelf life. User determines suitability of product for intended use and assumes all risks. Buyer's sole remedy shall be limited to the purchase price or replacement of product exclusive of labor or cost of labor.

NO OTHER WARRANTIES EXPRESS OR IMPLIED SHALL APPLY INCLUDING ANY WARRANTY OF MERCHANTABILITY OR FITNESS FOR A PARTICULAR PURPOSE. SIKA SHALL NOT BE LIABLE UNDER ANY LEGAL THEORY FOR SPECIAL OR CONSEQUENTIAL DAMAGES. SIKA SHALL NOT BE RESPONSIBLE FOR THE USE OF THIS PRODUCT IN A MANNER TO INFRINGE ON ANY PATENT OR ANY OTHER INTELLECTUAL PROPERTY RIGHTS HELD BY OTHERS.

Contact Sika:

Phone: 1-800-325-9504

Website: usa.sika.com

Our most current General Sales Conditions shall apply.

Please consult the Product Data Sheets prior to any use and processing.

SIKA ST. LOUIS

3400 Tree Court Industrial Blvd.

St. Louis, MO 63122

Phone: 800-325-9504

Fax: 636-225-2049

BUILDING TRUST

