

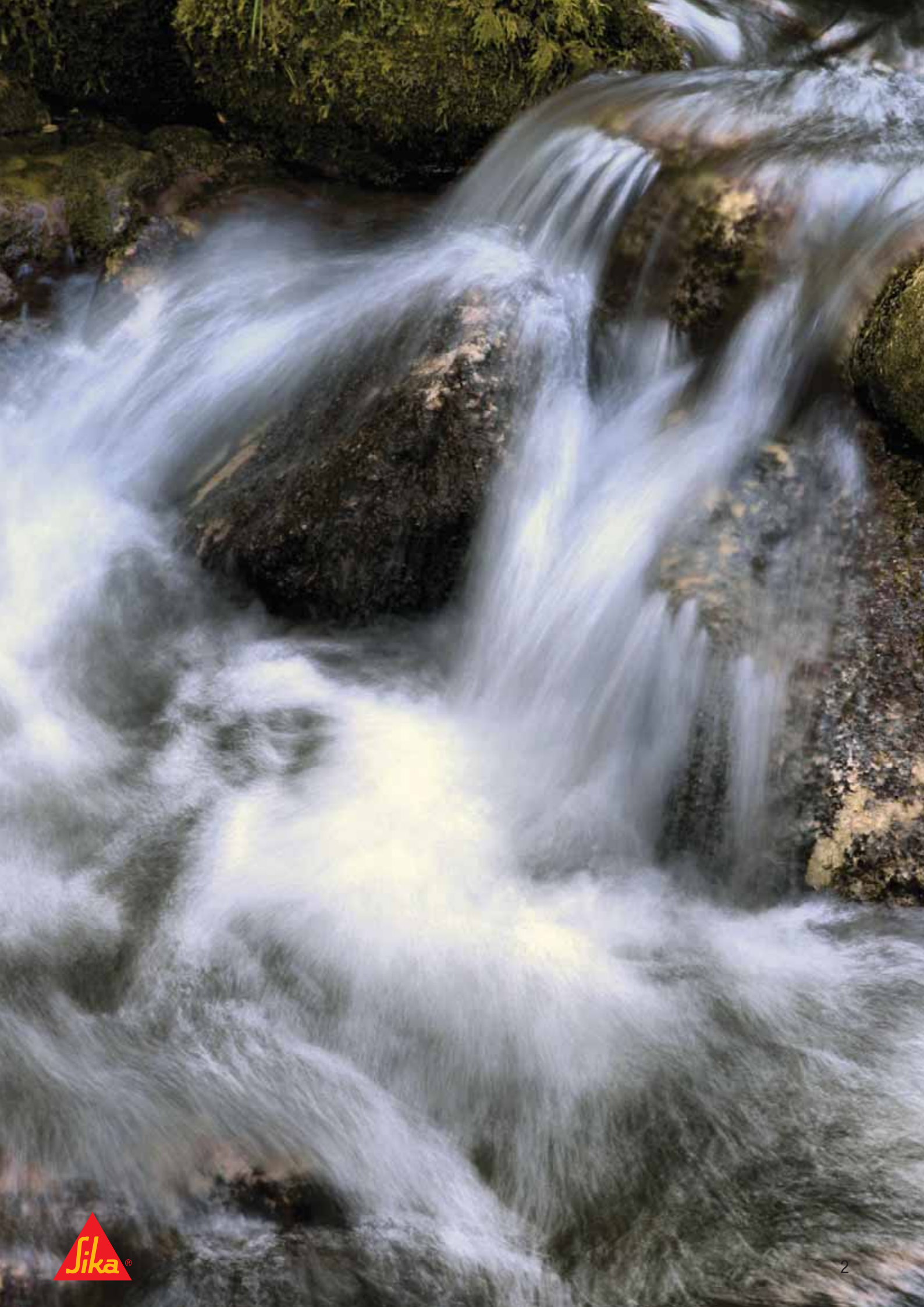

Sika Technologies and Solutions for Waste Water Treatment Plants

Sika®



Sika Waste Water Treatment Plant Solutions Contribute to a Sustainable Future

“Sika is committed to putting high-performance solutions into practice – to the benefit of our customers and for a sustainable development.”

Distribution of Earth's Water

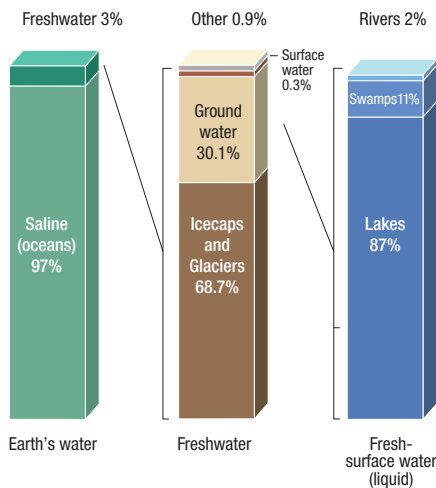

Earth water distribution, US Geological survey, 2009

The fresh water available on the earth amounts to only 3% of the total water – the balance being saline water from seas and oceans. Rivers and lakes that supply most of the water for the human uses only constitute 0.007% of the total water. (source: US geological survey, 2009). From these figures alone, it is clear we should do the maximum to minimise pollution of our rivers and lakes. Waste water from urban and agricultural areas is one of the most significant sources of pollution.

There is a wide diversity in the world regarding access to waster water treatment. While 90% of the waste water produced globally remains untreated, this situation is reversed in developed countries – for example, around the Leman Lake, more than 95% of the population is connected to a sewage treatment plant.

Sika contributes modestly to save water in the planet by providing long lasting construction and refurbishment solutions to prolong longevity of waste water treatment plants.

Sika Repair and Protection Solutions to Reduce Waste!

In a remedial work, significant amount of waste are generated: polluted concrete, chemical residue of old coatings, pails and bags. These wastes need to be disposed off in specific areas and contributes to CO₂ emission.

Sika provides long lasting repair and protection systems that help to extend the interval between maintenance and remedial work. Thanks to this, the quantity of waste is significantly reduced.



Content

The Sika Life Cycle Assessment Approach	4/5
Sustainable Refurbishment of Waste Water Treatment Plant	6/7
The General Process of Cleaning Waste Water	8/9
Exposure for Sewers	10/11
Sika Solutions for Sewers	12/13
Problems and Damages to Structures in WWTP	14/15
Aggressive Substances in Sewage – Sustained Attack on Concrete	16/17
Sika's Field Experience – Results of 17-Years of Experimental Testing of Protection Systems in an Aeration Tank	18/19
General Sewage Treatment Plant Refurbishment Consideration	20
General Sewage Treatment Plant Refurbishment Procedures	21
Overview of Sika Solutions for Each Structure in a WWTP	22/23
Sika Solutions for Screening Channels	24/25
Sika Solutions for Grit, Fat and Grease Chambers	26/27
Sika Solutions for Primary Sedimentation Tanks	28/29
Sika Solutions for Biological Tanks	30/31
Sika Solutions for Gasometers	32/33
Sika Solutions for Digestion Tanks	34/35
Sika Solutions for Filtration Beds	36/37
Sika Solutions for Secondary Sedimentation Tanks	38/39
Sika Solutions for Technical Service Buildings	40/41
Other Sika Solutions	42/43
Sika Solutions for Concrete in New Constructions	44/45
Case Studies	46/47

The Sika Life Cycle Assessment Approach



Life Cycle Assessment (LCA) is a standardized method to assess and compare the inputs, outputs and potential environmental impacts of products and services over their life cycle. LCA's are increasingly recognised as the best way to evaluate the sustainability of products and systems.

Sika carries out LCA's according to the ISO 14040 series and the Standard EN 15804. The impact assessment methodology used is CML 2001.

The data for the Sika LCA is based on public databases, such as those from ecoinvent, the European Reference Life Cycle Database (ELCD) and PE-GaBi, plus the specific data from Sika production plants and products.

Sika evaluates all impact categories and resource indicators deemed as important according to the relevant standards.

Cumulative Energy Demand (CED), Global Warming Potential (GWP) and Photochemical Ozone Creation Potential (POCP) are considered to be most relevant for concrete repair & protection:

- Cumulative Energy Demand (CED) is the total amount of primary energy from renewable and non-renewable resources.

- Global Warming Potential (GWP), is the potential contribution to climate change due to greenhouse gases emissions.
- Photochemical Ozone Creation Potential (POCP) is the potential contribution to summer smog, related to ozone induced by sunlight on volatile organic compounds (VOC) and nitrous oxides (NOx).

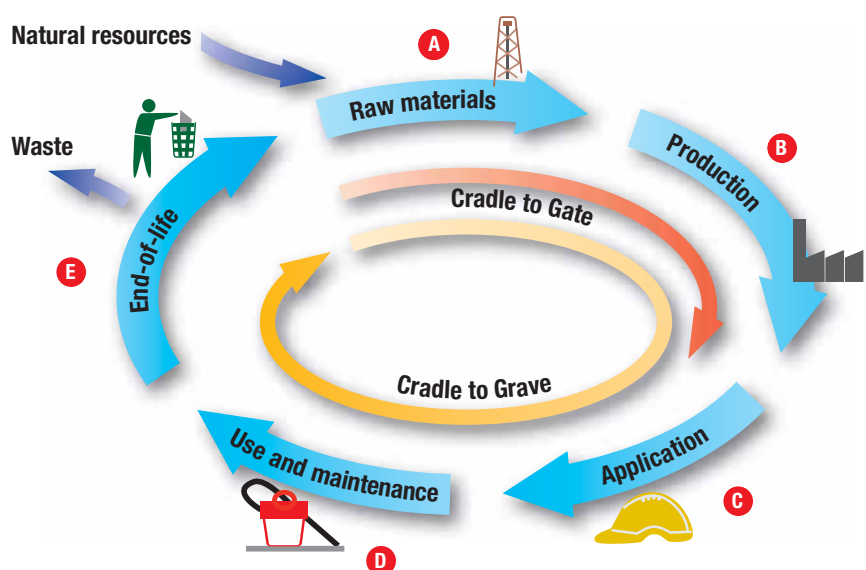

Sustainable Refurbishment of Waste Water Treatment Plants



Sika LCA's on refurbishment strategies for waste water treatment plants are based on a 'Cradle to Grave' approach. Potential environmental impact of products for concrete repair and protection are investigated from raw material extraction, production, application and use to final disposal at end of life. Construction and end-of-life scenario of the reinforced concrete structure itself are excluded.

Biological tank

1000 m² exposed surface, reinforced concrete without initial protection. First refurbishment after 20 years use.

	Scenario 1: Minimum Investment	Scenario 2: Durable Solutions
Initial Repair	Ultra high pressure water jetting, reinforcement corrosion protection and concrete repair	
Concrete Protection	Polymer modified cementitious resurfacing mortar	Sikagard®-720 EpoCem® Epoxy cement resurfacing mortar Sikagard®-63 N High build epoxy coating
Life span based on field investigation Assumption for LCA	7.5 years 10 years	20 years 20 years
Refurbishment & Refreshing	<ul style="list-style-type: none"> ■ Ultra high pressure water jetting ■ Reinforcement corrosion protection ■ Concrete repair ■ Polymer modified cementitious resurfacing mortar 	Sikagard®-63 N High build epoxy coating (refreshing coat)

Sustainable Refurbishment of Waste Water Treatment Plants

Sikagard® state of the art concrete protection systems with field proven durability allows 40 years of operation with only one short shut down period for refreshing the top coat.

Scenario 1: Polymer modified cement protective coating system



Full refurbishment every 10 years

Scenario 2: Sikagard® State of the Art Protective Coating System



Refurbishment

Refreshing coat

Cumulative Energy Demand (CED)

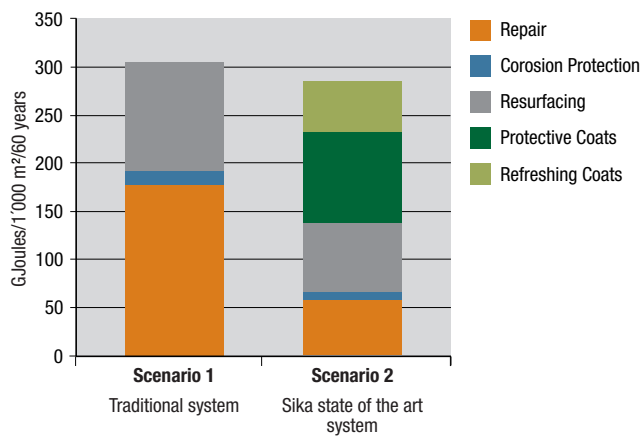

Even using epoxy based materials to increase durability, **scenario 2** has a slightly lower CED than scenario 1 due to its greater resource efficiency (lower material consumption over the whole life cycle). This is an equivalent saving of 550 liters of oil over the life cycle period (60 years).

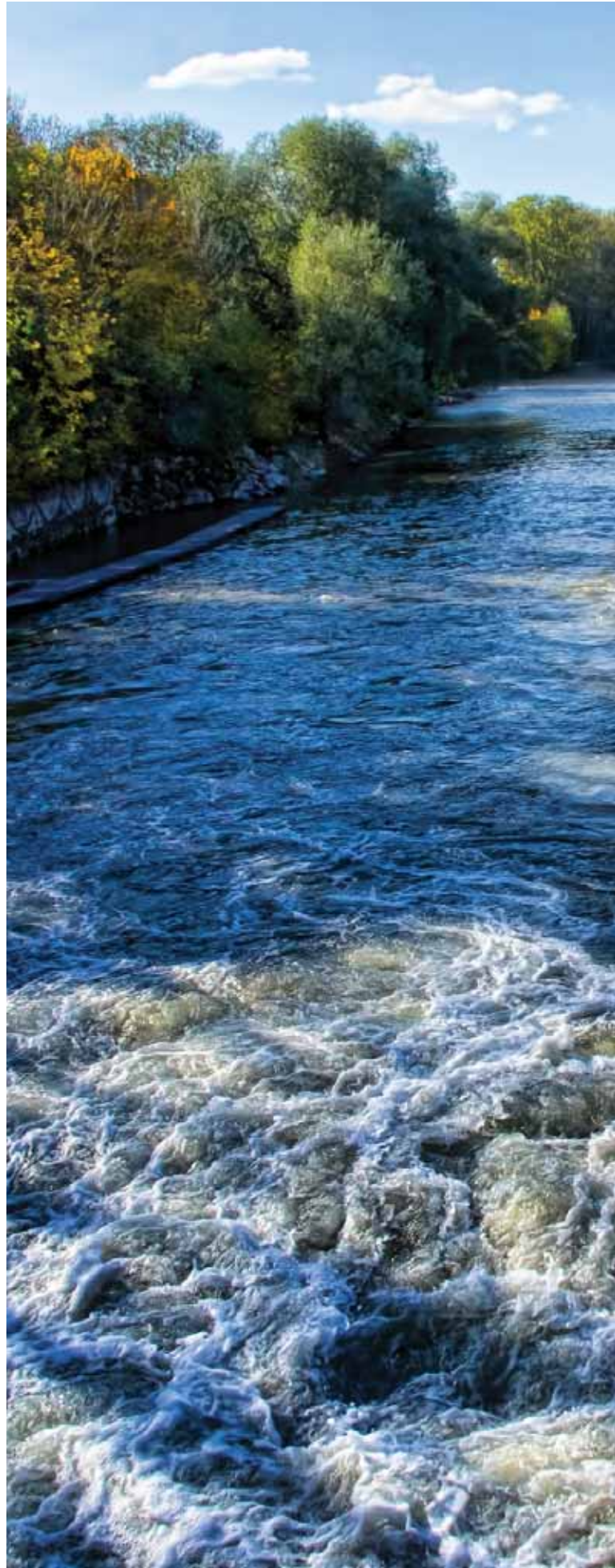



Photochemical Ozone Creation Potential (POCP)

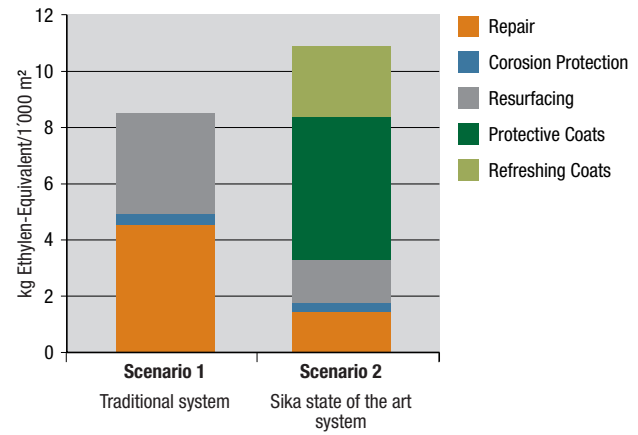

Scenario 2 has a higher POCP impacts due to the use of epoxy coating. However the impact to the environment is minimal. The difference between the two scenarios over the life cycle period (60 years) is only 2.5 Kg of Ethylen equivalent. This represents only 40 g per year (~1 bottle of nail polish remover per year).

Global Warming Potential

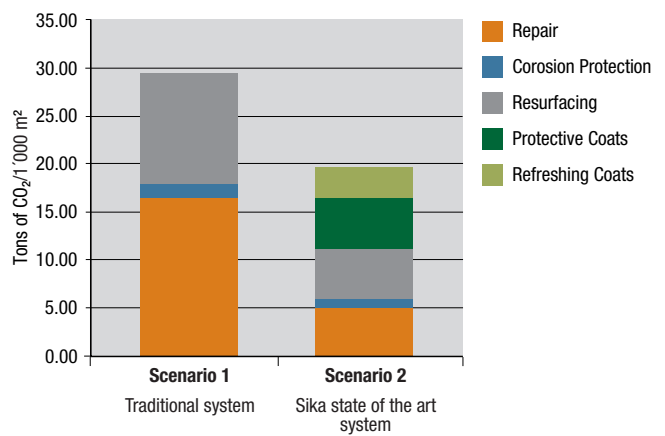

The greater resource efficiency of **scenario 2** allows savings of 10 tons of CO₂ over the life cycle period (60 years). Comparing this value to limit of the European Union strategy adopted in 2007 (not more than 130 g of CO₂ per km in 2015), this saving is equivalent to a car's CO₂ emission during ~1'300 km per year.

Conclusion

Overall saving for the plant owner with positive incidence on sustainability:

The appropriate strategy can have a beneficial impact:

- by reducing the frequency of refurbishment cycles,
- by improving the resource efficiency and the environmental performance of the refurbishment process,
- by providing a more sustainable solution.

The General Process of Cleaning Waste Water

The cleaning procedure of a modern waste water in treatment plant can be summarized in 6 different steps:

Sewer System

see pages 10 – 13

Generally, waste water is collected and transported via a network of pipes and pumped to the waste water treatment plant.

Mechanical Treatment

see pages 24 to 29 & 38/39

This includes the screening to remove large objects in the sewage water and the whole sedimentation procedure as well. Sand and grits, oil, grease, fat, floating and heavy solids will be separate from the waste water. The primary sludge after settlement will be skimmed off.

Construction Elements:

- a** Screening channel
- b** Grit removal chamber, combined with fat and grease removal
- c** Primary sedimentation tanks
- d** Secondary sedimentation Plant

Biological Treatment

see pages 30/31

The pretreated waste water will be aerated in biological tanks. By adding oxygen special bacteria will be created to reduce the biodegradable soluble organic contaminants in the waste water.

Construction Elements:

- e** Aerated and anoxic biological tanks



Chemical Treatment

see pages 30/31

The aim of the chemical treatment is to remove phosphorus by adding special chemicals as ferric chloride. This results in a chemical flocculation that will be removed further in the filtration process.

Construction Elements:

- e** Aerated and anoxic biological tanks

Filtration

see pages 36/37

All the remaining particles after the biological and chemical treatment will be retained in special sand filter beds. The cleaned water is discharged to the receiving environment.

Construction Elements:

- b** Filtration beds

Sludge Treatment

see pages 32 to 35 and 40/41

Sludge from the primary and secondary sedimentation will be digested to reduce the amount of organic matter. Within this process, biogas (methane, CO₂) will be produced that will be stored in gasometers. Afterwards, the digested sludge will be dewatered first before it will be disposed into an incinerator or landfill.

In the energy building, methane gas will be used to produce electricity and heat.

Construction Elements:

- g** Digestion tanks
- h** Gasometers
- i** Energy building

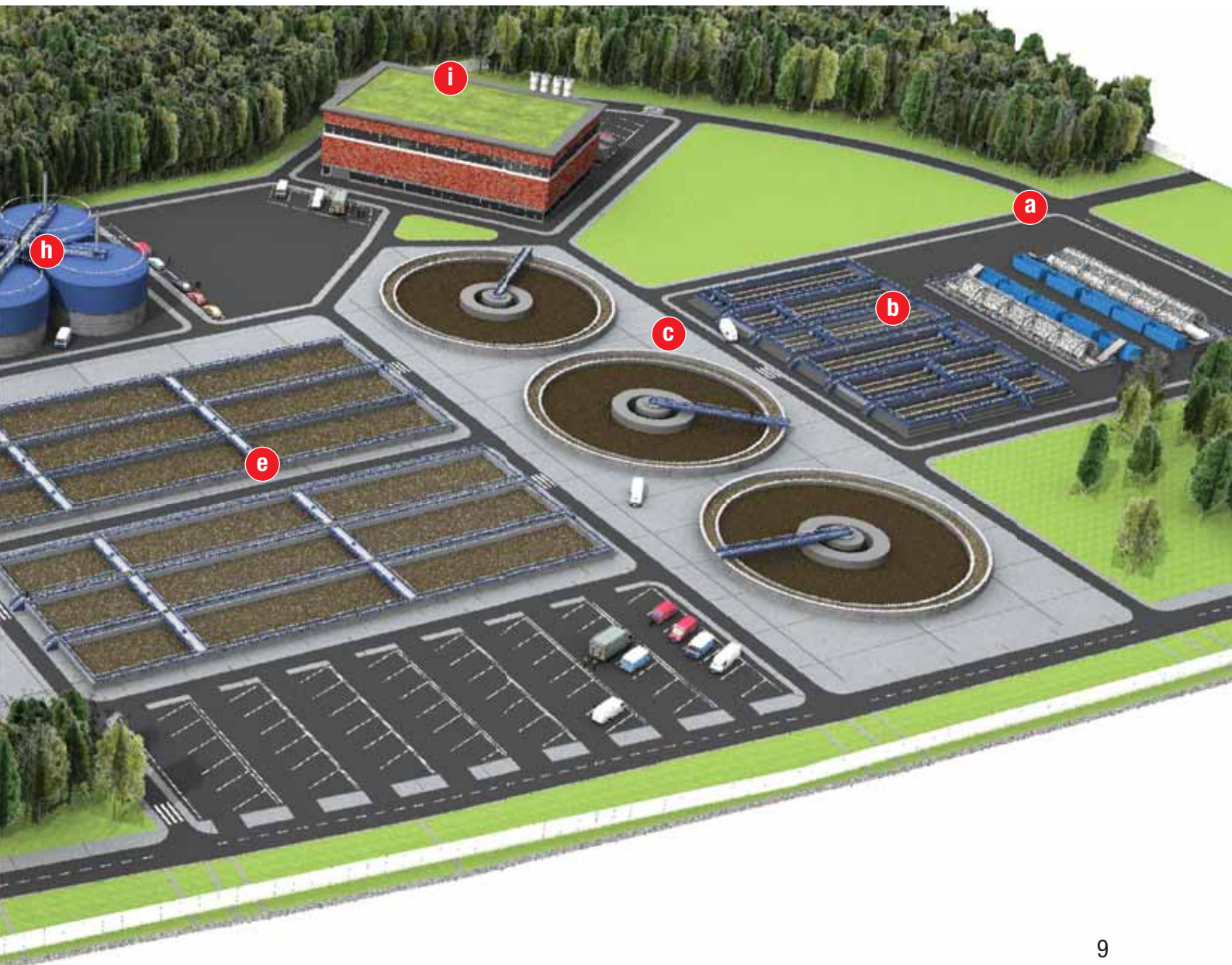

Exposures for Sewers

Most accessible sewers are more than 50 years old and in most cases are made of tamped or reinforced concrete in round, rectangular or ovoid shapes.

Generally, sewers present three different zones of stresses having each specific issues:

A: biogenic aggression, runoff, storm water, waste water or condensation

B: runoff, storm and waste water, erosion and corrosion defects

C: waste water, erosion and abrasion

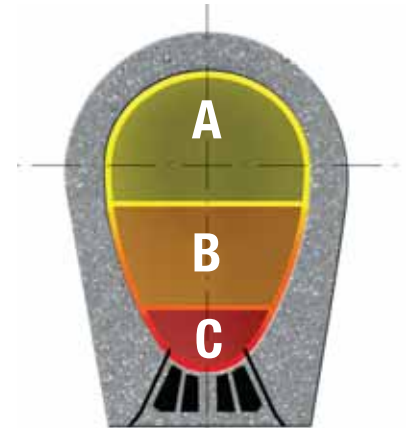

1 Damages at the bottom:

Heavy abrasion and erosion of the concrete and prefabricated elements are often found at the bottom of the sewers.

In general rules, these elements shall be replaced and reassembled properly by gluing them in place with an epoxy adhesive.



2 Localised defect of the concrete:

Lateral walls and the crown often show localised defects of the concrete and some time defects due to the corrosion of the reinforcement. After appropriate preparation, these defects can be repaired using sulphate resistant repair mortars.



3 Full degradation of the concrete surface:

The resistance of tamped concrete against a strong water current is generally not enough and often it is found the full surface of the concrete is eroded. It is recommended in these zones to proceed with a full resurfacing.



4 Cracks with water leaks:

Due to shrinkage or settlements, concrete in sewers often crack. These cracks need to be filled in order to prevent leakage of pollutant to surrounding ground water. It is often necessary to use expanding materials to fill these cracks.



5 Damages at the crown:

Exposed tamped concrete surfaces show very low resistance against carbonation and the aggressive substances contained in the waste water. Therefore, these surfaces can be protected using **EpoCem**® technologies



which are extremely resistant and watertight against urban waste water.

At the crown area, the structure can be protected against condensation water using a hydrophobic impregnation.



Sika Solutions for Sewers

The products and systems to repair sewers will vary according to the extent of damages, performance requirements, expected durability and budget. Sika can answer all the needs by proposing products and systems to suit all requirements with the backup of worldwide references and experience.



Repair Work

Sika MonoTop®-910 N

1-component anticorrosion slurry and bonding primer (when relevant)

Sika MonoTop®-412 NFG

1-component, polymer modified, sulphate resistant repair mortar

Sika® Abraroc® SR

1-component, hydraulic abrasion resistant repair mortar, hand or dry spray applied.

Sikagard®-820 Abraroc®

1-component, thin layer resurfacing mortar with wet abrasion resistance, sulphate and mild acid resistant



Surface Protection

Sikagard®-720 EpoCem®

Epoxy cement resurfacing mortar with high resistance against urban waste water

Sikagard®-740 W/-706 Thixo

Hydrophobic impregnation to protect the concrete crown against condensed water



Adhesive / Anchoring / Cracks Treatment

Adhesive

Sikadur®-31

Epoxy adhesive with high bonding on various substrate

Anchoring

SikaGrout®-311/-314

Fluid mortar for anchoring or grouting of elements

Cracks treatment

Sikadur-Combiflex® SG System

High performance joint and crack waterproofing system made of a FPO tape and epoxy adhesive

Injections / Filling

Sika® Injection-105 RC

2-component expanding polyurethane foam to stop water leakage and temporary watertightness of cracks to allow further permanent injection

Sika® Injection-201 CE

2-component, elastic PUR resin for permanent and durable filling of the cracks, complying with EN 1504-5 as crack filling material for concrete (U(D1) W(2) (1/2/3) (9/30)

Sikadur®-52

2-component, fluid epoxy resin for structural injection of the cracks

Sika® InjectoCem-190

2-component, micro-cement injection

Filling (floor)

SikaFix®-HS

Fast reacting, 2-component hybrid (organic and mineral) resin to fill cavities



Problems and Damages to Structures in a WWTP

Screening Channel

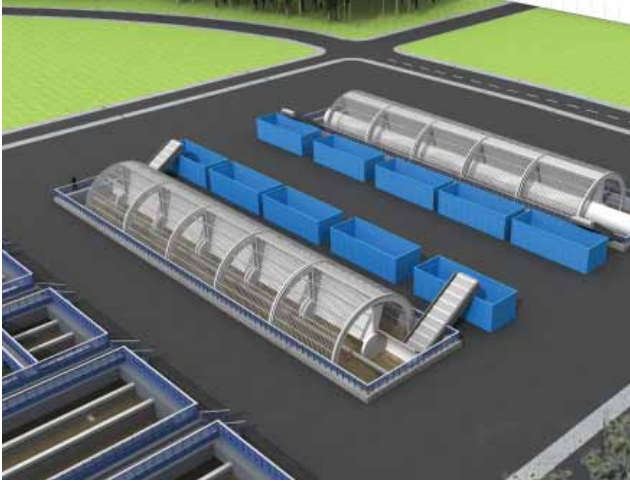

- Abrasion and erosion due to sand, grit or other heavy particles
- Chemical attacks due to aggressive waste or industrial water
- Leakage due to cracks, untight joints or damaged concrete

Grit, Fat & Grease Chamber

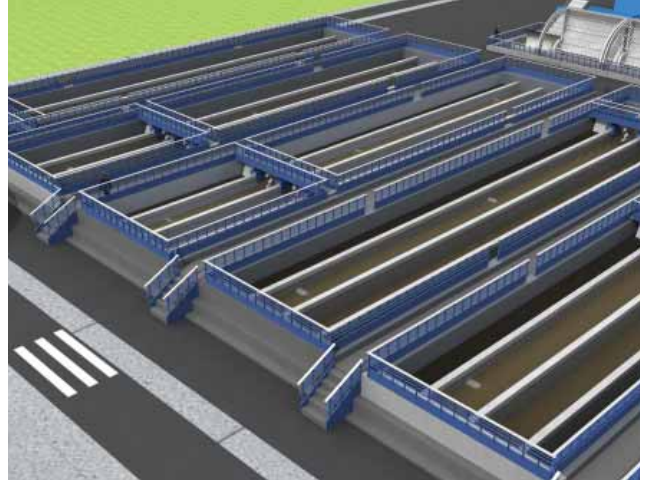

- Abrasion and erosion due to sand, grit or other heavy particles
- Chemical attacks due to aggressive waste or industrial water
- Leakage due to cracks, untight joints or damaged concrete

Gasometers



- Steel corrosion
- Untight joints
- Sulfuric acid damages

Digestion Tanks



- Concrete damage due to sulfuric acid
- Leakage due to damaged waterproofing
- Cracks due to thermal expansion or shrinkage

Primary Sedimentation Tanks

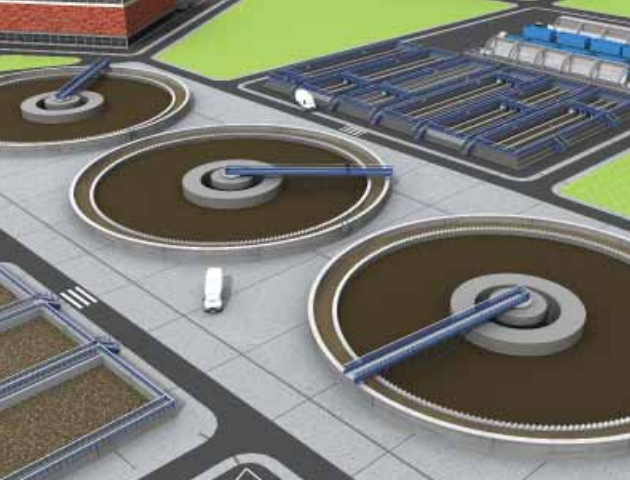

- Chemical attacks due to aggressive waste or industrial water
- Leakage due to improper waterproofing
- Cracks due to thermal expansion or shrinkage
- Steel reinforcement corrosion due to low concrete cover
- Mechanical abrasion at the rolling pad

Biological Tanks

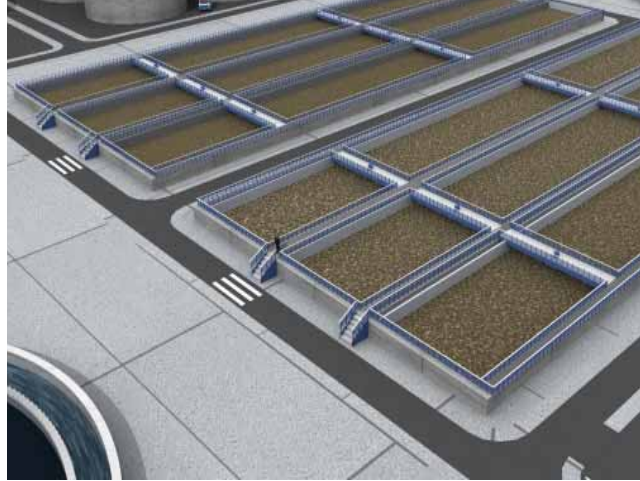

- Erosion due to water flow
- Chemical attacks due to aggressive waste or industrial water
- Leakage due to damaged waterproofing
- Cracks due to thermal expansion or shrinkage
- Steel reinforcement corrosion due to low concrete cover

Filtration Beds



- Abrasion due to sand
- Leakage due to damaged waterproofing
- Cracks due to thermal expansion or shrinkage

Secondary Sedimentation Tanks

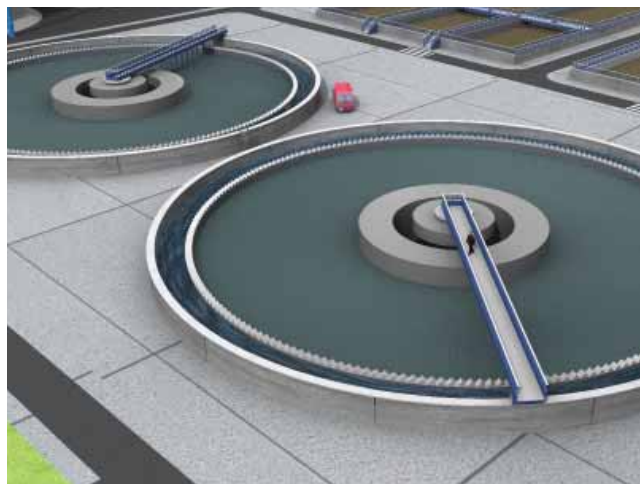

- Leakage due to damaged waterproofing
- Cracks due to thermal expansion or shrinkage
- Mechanical abrasion at the rolling pad

Aggressive Substances in Sewage – Sustained Attack on Concrete



The type and extent of concrete damage to be expected in all areas of sewerage systems, is determined by the corrosiveness of the substances present, by the quality of the existing concrete and by the quality any protective treatments.

The level of concrete corrosiveness in the different parts of the sewerage system exposed to waste water can be assessed on the basis of EN 206-1:2000. This European standard defines three levels of chemical attack (XA1, XA2 and XA3 – low, severe and very severe respectively) on concrete. By reference to the pH value, this is useful for rain water and ground water – but not always sufficient for sewage due to other factors such as Biogenic Sulfuric Acid corrosion (BSA –see further).

The status of the water quality under this standard is however still an essential basis for selecting and applying suitable repair systems, provided all other relevant factors such as BSA are also carefully considered. The repair system selection is of course also made on the basis of the concrete quality and in terms of the depth of damage, chloride levels and substrate strength etc. For very serious chemical attack, additional treatment in the form of a surface protection system is required, over and above the concrete repair and replacement.

This so-called Biogenic Sulfuric Acid corrosion (BSA) is usually the most serious cause of damage to the interior of biogas tanks. Sulfuric and sulfurous acids can cause concrete erosion rates of 0.5 – 10.00 mm per annum; in extreme cases erosion of up to 20 mm has been measured.

It is therefore clear that as a result of these chemical processes involved in biogas generation, safe, effective and durable protective measures for the steel and concrete surfaces are required.

Biogenic Sulfuric Acid Corrosion

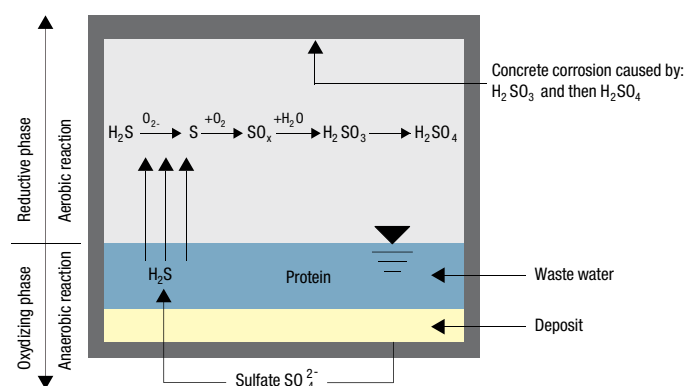

Danger in delay – Biogenic Sulfuric Acid corrosion (BSA)

The chemical composition of biogas consists mainly of methane and variable concentrations of carbon dioxide, water vapour, hydrogen sulfide, nitrogen, oxygen and hydrogen.

The proteins present in the fermenters break down into amino acids. These amino acids and the sulfates present form, amongst other things, hydrogen sulfide (H₂S). This moves to the gas compartment by diffusion, where it is oxidised and condenses on the walls and soffits as elementary sulfur deposits. This sulfur is then used as an energy source by thiobacteria and is thereby converted primarily to sulfurous (H₂SO₃) and then to sulfuric acid (H₂SO₄). This “biogenically” formed sulfuric acid aggressively corrodes metal components and severely attacks concrete, destroying it progressively from the inside.

Exposure Class as EN 206-1: 2000

Chemical Characteristics	Test Methods	XA1	XA2	XA3
Sulfate (SO ₄ ²⁻) in mg/l	EN 196-2	≥ 200 and ≤ 600	> 600 and ≤ 3 000	> 3 000 and ≤ 6 000
pH	ISO 4316	≤ 6.5 and ≥ 5.5	< 5.5 and ≥ 4.5	< 4.5 and ≥ 4.0
Aggressive CO ₂	prEN 13577: 1999	≥ 15 and ≤ 40	> 40 and ≤ 100	> 100 to saturation
Ammonium (NH ₄ ⁺) in mg/l	ISO 7150-1 or ISO 7150-2	≥ 15 and ≤ 30	> 30 and ≤ 60	> 60 and ≤ 100
Magnesium (Mg ²⁺) in mg/l	ISO 7980	≥ 300 and ≤ 1 000	> 1 000 and ≤ 3 000	> 3 000 to saturation



Sika's Field Experience – Results of 17-Years of Experimental Testing of Protection Systems in an Aeration Tank

In 1991, in one of the largest sewage treatment plants in Europe, different coatings systems were applied in an aeration tank and left in real life exposure. Investigations were carried out at various time intervals to assess the long term performances of the installed coating systems.

Note: Full article available upon request

Life Expectancy in Aeration Tanks

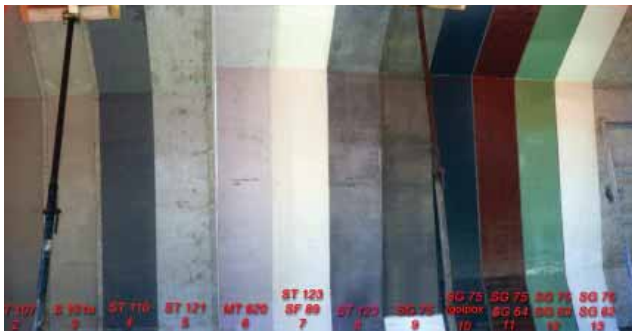
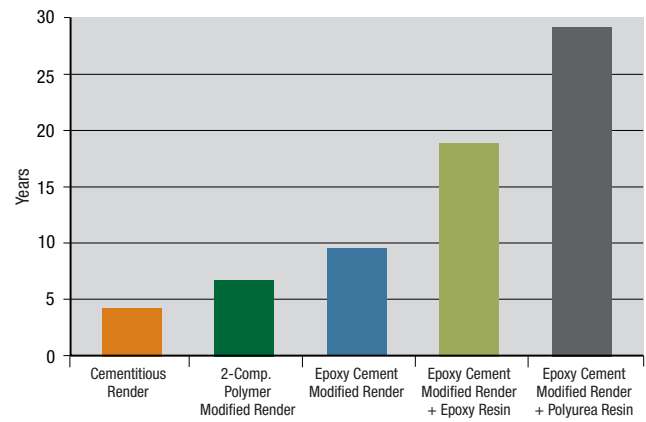

View of the various systems right after application in September 1991



Overview of the test areas in 2008

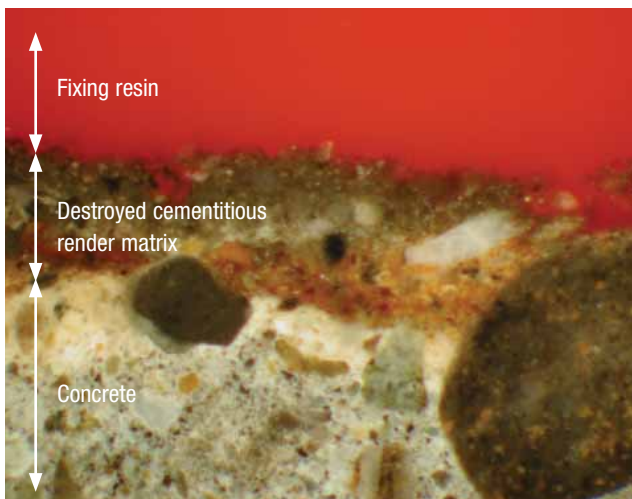

Cementitious mortars:

Because the sewage dissolves the cement paste, continuous erosion begins within a short period of time. The binder matrix is weakened and the aggregates then break away.

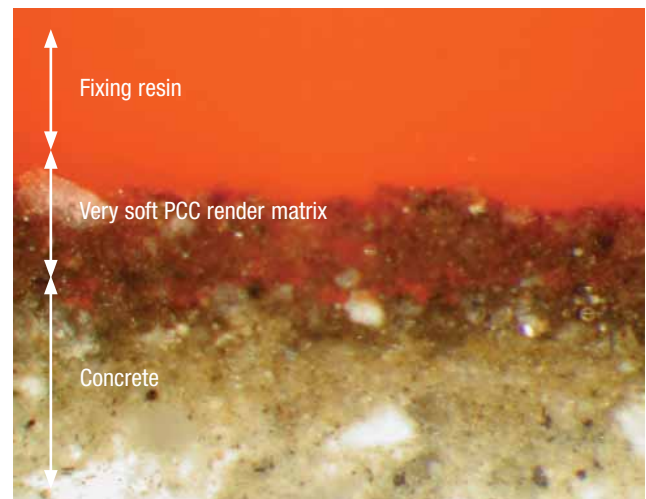

Polymer modified cementitious mortars:

Although of longer durability than a normal cementitious mortar, when subject to aggressive chemical environments, their resistance is significantly reduced. When not overcoated, they can only provide protection for a short term.

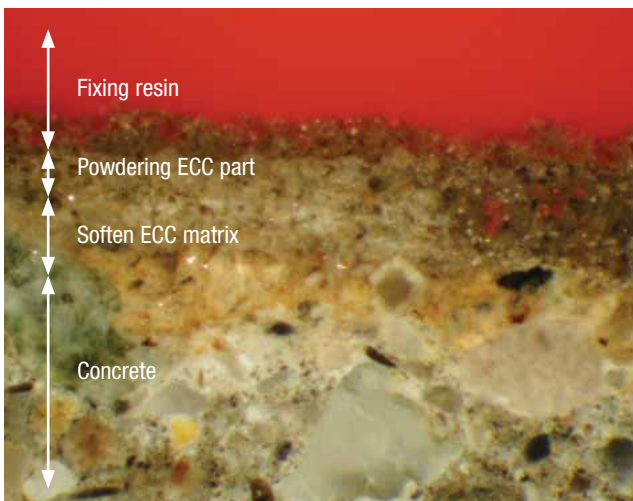

Epoxy cement mortar:

The epoxy resin component improves the chemical resistance of the cement matrix. But due to the level of aggressiveness in waste treatment plant, they can only provide protection for a medium term.

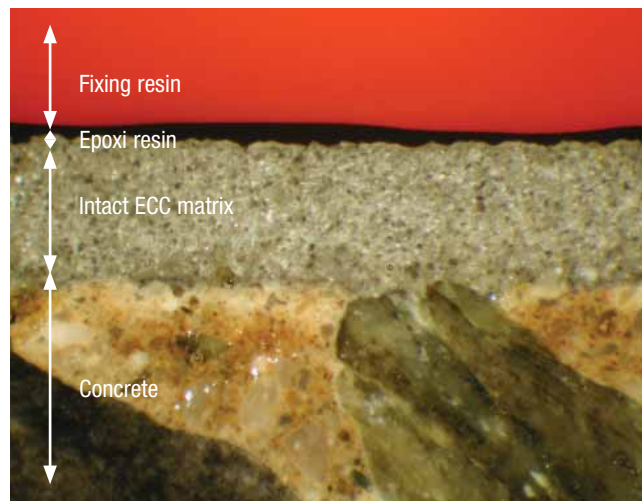

Resin coatings:

According to their formulations, resin coatings (epoxy or polyurea) can bring long term durability. However, particular attention must be paid to prevent osmotic blister by the use of **EpoCem**® levelling mortar as pre-treatment.

Sikagard®-720 **EpoCem**® does not require curing and allows for a fast over-coating with a reactive resin. This allows a quicker and safer application process than normal cement render.

General Sewage Treatment Plant Refurbishment Considerations

Before defining the repair and protection strategy including a detailed refurbishment procedures, the specific sewage treatment plant on refurbishment requirements must be considered. These requirements can have an important influence in determining the correct design, planning and construction procedures, together with the future maintenance works necessary for the sewage treatment plant. Examples of these project related requirements are outlined below.

Durability

Remedial works on a sewage water treatment plant can have a significant cost; hence the frequency of remediation work should be as far apart as possible. Therefore products used in these remedial works must provide adequate durability to extend the defined service life.

Duration of Closure

During the time of remedial works, either the plant is completely or partly shut down leading to extra demand on neighbouring plants. The remedial works selected shall minimise this duration of closure.

System Compatibility

Remedial works on complex large sewage water treatment plants often demand a complete and integrated system build-up. It is very important all of the products used are compatible. The use of one full range system supplier with proven compatible products and systems ensures this is achieved.

Total Life Cycle Costing

The total costs must take into account the actual costs of the remedial works plus the maintenance costs of the defined service life. This significantly influences the selection of the appropriate refurbishment concept and the specific materials to be used.

Exposures / Site Conditions

The specific site exposure and environmental conditions, such as the climate, access and space for material application, also significantly influences the selection of the refurbishment concept, the appropriate materials and application techniques.

Ecology







Environmental friendly and sustainable materials such as solvent free products help to safeguard the environment. These are increasingly an important requirement and in some countries, additional taxes now have to be paid for products that release Volatile Organic Compounds (VOC's).



General Sewage Treatment Plant Refurbishment Procedures

The repair and protection of sewage treatment plants must always be executed according to all relevant local Standards and Regulations. After a detailed condition survey and root cause analysis, the right procedures for successful refurbishment can be defined.

Standards (such as European Standard EN 1504-9) define Principles and Methods to refurbish damaged concrete. Please refer to our Brochure “The Repair and Protection of Reinforced Concrete with Sika” for more information relating to repair and protection according to EN 1504-9.

Types of Damage / Defects (Examples)		Possible Principles / Methods	
		For the Repair	For the Protection
Concrete Spalling / Scaling of Concrete Surface		<ul style="list-style-type: none"> Concrete Restoration (Method 3.1 / 3.2 / 3.3) 	<ul style="list-style-type: none"> Protection against Ingress (Methods 1.1 / 1.2 / 1.3) Physical Resistance (Method 5.1 / 5.2 / 5.3)
Steel Reinforcement Corrosion		<ul style="list-style-type: none"> Restoring passivity (Method 7.1 / 7.2) 	<ul style="list-style-type: none"> Increasing resistivity (Method 8.1 / 8.2 / 8.3) Cathodic Control (Method 9.1) Cathodic Protection (Method 10.1) Control of anodic areas (Methods 11.1 / 11.2 / 11.3)
Structural Cracks		<ul style="list-style-type: none"> Crack Injection (Methods 4.5 / 4.6) 	<ul style="list-style-type: none"> Structural Strengthening (Methods 4.1 / 4.3 / 4.4 / 4.7)
Non-Structural Cracks		<ul style="list-style-type: none"> Filling of cracks (Method 1.5) 	<ul style="list-style-type: none"> Protection against Ingress (Method 1.1 / 1.2 / 1.3) Moisture Control (Method 2.1 / 2.2 / 2.3) Physical Resistance (Methods 5.1 / 5.2 / 5.3)
Chemical Attacks		<ul style="list-style-type: none"> Adding mortar or concrete (Method 6.3) 	<ul style="list-style-type: none"> Resistance to chemicals with coating (Method 6.1)
Structural and Non Structural Steel Corrosion		<ul style="list-style-type: none"> Not applicable 	ISO 12944 Refers to the Corrosion Protection of Steel Structures

Overview of Sika Solutions for Each Structure in a WWTP

Screening Channel

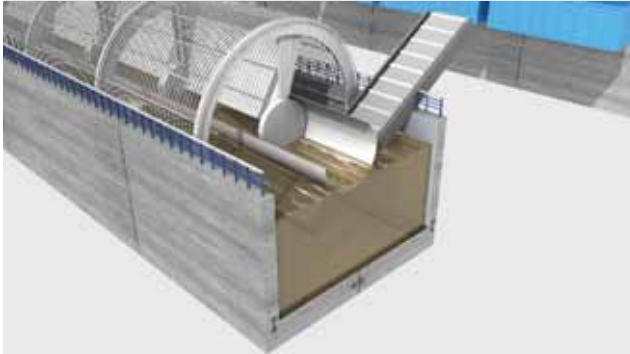

- Abrasion and erosion:
Sika® Abraroc® SR or **Sikagard®-820 Abraroc®**
- Chemical attacks:
Sikagard®-720 EpoCem® + **Sika® Poxitar F**
- Cracks, untight joints:
Sikadur-Combiflex® SG or **Sikaflex® Pro-3**

Grit, Fat & Grease Chamber

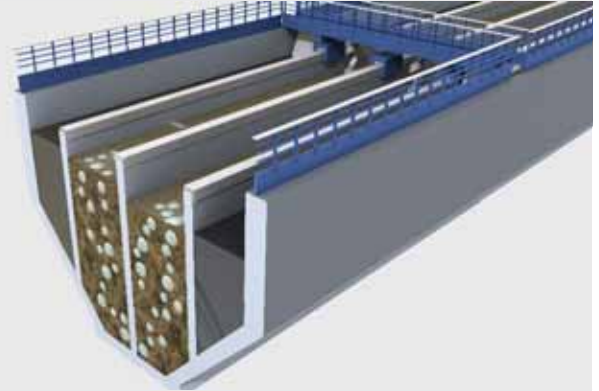

- Abrasion and erosion:
Sika® Abraroc® SR or **Sikagard®-820 Abraroc®**
- Chemical attacks:
Sikagard®-720 EpoCem® and **Sikagard®-63 N**
- Cracks, untight joints:
Sikadur-Combiflex® SG or **Sikaflex® Pro-3**

Gasometers

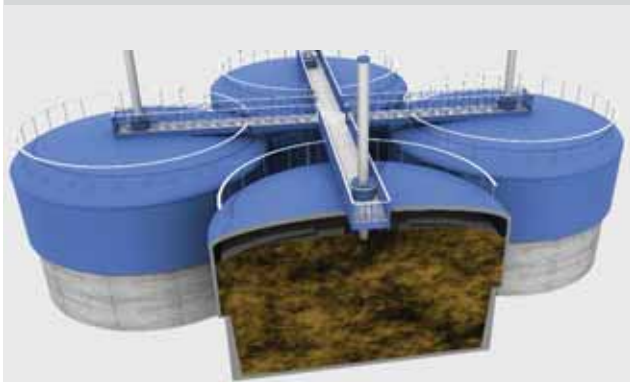

- Steel corrosion:
Sika® Icosit® 6630 System
or **SikaCor® EG System**
- Steel joint:
Sikaflex® TS Plus
- Sulfuric acid attack:
Sika® Permacor® 3326 EG H
or **Sikalastic®-844 XT**

Digestion Tanks

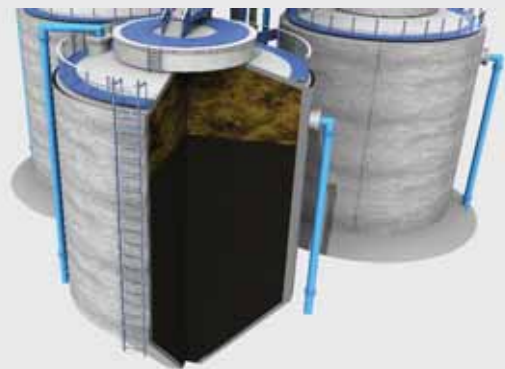

- Sulfuric acid attack and waterproofing:
Sika® Permacor® 3326 EG H
or **Sikalastic®-844 XT**
- Cracks:
Sikadur-Combiflex® SG
- Chemical resistant joint:
Sikaflex® Pro-3

Primary Sedimentation Tanks

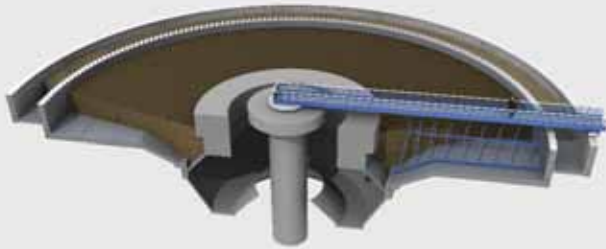

- Chemical attacks and damaged waterproofing:
Sikagard®-720 EpoCem® and **Sika® Poxitar F**
- Cracks, untight joints:
Sikadur-Combiflex® SG or **Sikaflex® Pro-3**
- Damaged concrete and steel reinforcement corrosion:
Sika Monotop®-412 NFG
SikaTop® Armatec®-110 EpoCem®
- Mechanical abrasion:
Sikadur®-42 or **Sika® Icosit®-KC 330 FK**

Biological Tanks

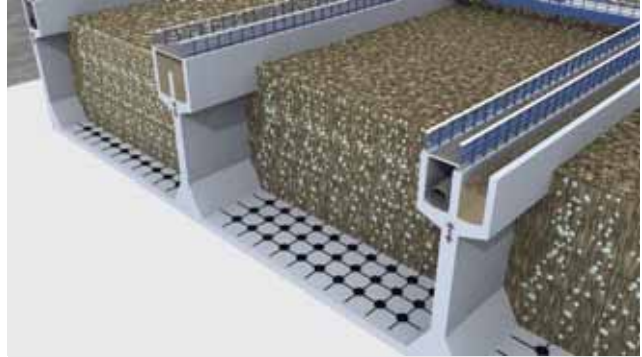

- Chemical attacks and damaged waterproofing:
Sikagard®-720 EpoCem® and **Sika® Poxitar F**
- Cracks, untight joints:
Sikadur-Combiflex® SG or **Sikaflex® Pro-3**
- Damaged concrete and steel reinforcement corrosion:
Sika Monotop®-412 NFG
SikaTop® Armatec®-110 EpoCem®

Filtration Beds

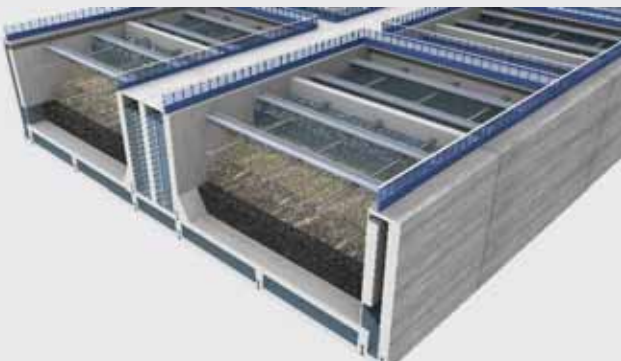

- Abrasion:
Sika® Abraroc® SR or **Sikagard®-820 Abraroc®**
- Damaged waterproofing:
Sikagard®-720 EpoCem®
- Cracks:
Sikadur-Combiflex® SG or **Sikaflex® Pro-3**

Secondary Sedimentation Tanks

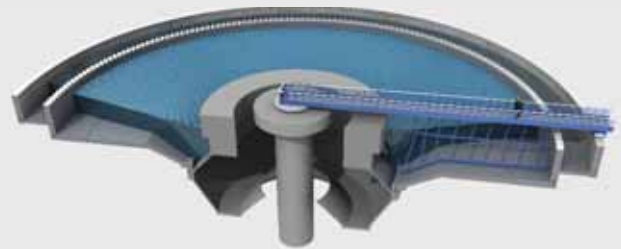

- Damaged waterproofing:
Sikagard®-720 EpoCem®
- Cracks:
Sikadur-Combiflex® SG or **Sikaflex® Pro-3**

Sika Solutions for Screening Channels

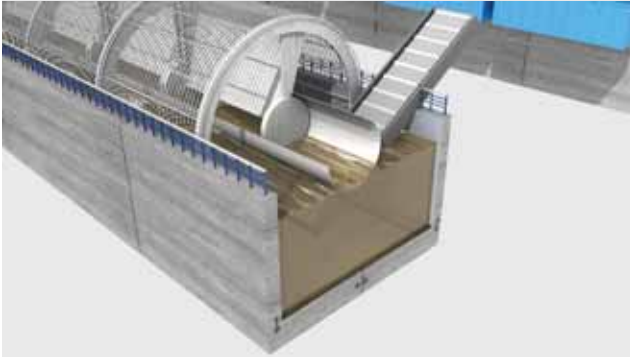

General Description & Main Requirements

Screening Channel

In large treatment plant, the removal of large objects is automatically performed in the screening channel.

Typical problems encountered are:

- Abrasion and erosion due to sand, grit or other particles.
- Chemical attacks, depending on the aggressiveness of the waste or industrial water.
- Leakage and risk of pollution due to cracks, untight joints or damaged concrete.

Sika Solutions for Hydraulic Abrasion

In waste water treatment plant, erosion is mainly due to abrasion or by chemical attack.

Erosion damage results from the abrasive effect of waterborne silt, sand, gravel, and other debris being circulated over a concrete surface during operation.

The compounds present in hardened Portland cement are attacked by the aggressiveness (low pH) of the waste water.

Sika since decades is specialised in this field and has developed with major partner products that address the above issues:

Sika® Abraroc® SR:

- Hydraulic resistant mortar
- Sulfate resistant
- Mild acid resistant
- Spray applied

Sikagard®-820 Abraroc®:

- Thin layer resurfacing mortar with wet abrasion resistance
- Sulfate resistant
- Mild acid resistant





Typical Detail

- 1 Host concrete
- 2 Abraded surface
- 3 Over laying with
Sika® Abraroc SR

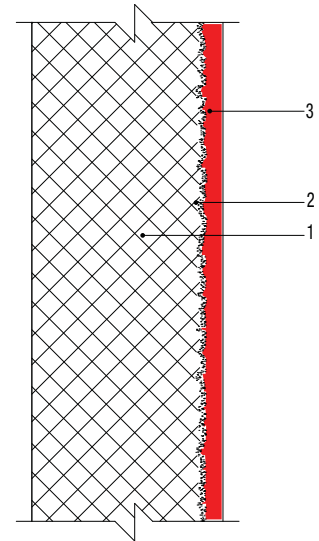

Other Typical Problems and Sika Solutions:

- Chemical attacks:
Sikagard®-720 EpoCem® and **Sika® Poxitar F**
- Cracks, untight joints:
Sikadur-Combiflex® SG or **Sikaflex® Pro-3**
- Damaged concrete and steel reinforcement corrosion:
Sika Monotop®-412 NFG
SikaTop® Armatec®-110 EpoCem®

Sika Solutions for Grit, Fat and Grease Chambers

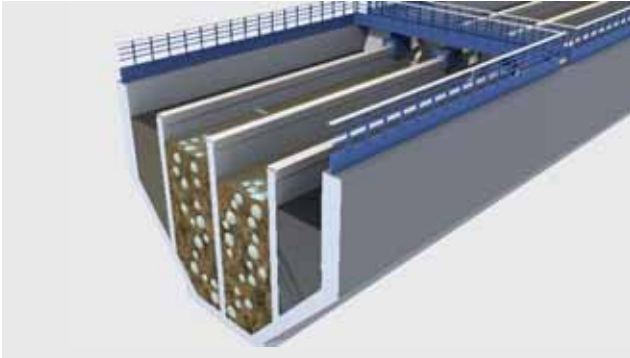

General Description & Main Requirements

In some plants, pre-treatment may include a grit channel where the waste water velocity is adjusted to allow settlement of the sands/grits or other hard particles. Sands/Grits must be removed as they may damage pumps or other equipments.

Fat and grease removal is generally done in large plant in the primary settlement tank using mechanical surface skimmers.

Typical problems encountered are:

- Abrasion and erosion due to sand, grit or other particles.
- Chemical attacks depending on the aggressiveness of the waste or industrial water.
- Leakage and risk of pollution due to cracks, untight joints or damaged concrete.

Sika Solutions for Untight Joints

Very often in waste water treatment, joints sealed with average sealant fail due to the lack of chemical resistance of these products. Instead of proceeding to the full removal of the failed joint, Sika has developed joint system that can be applied over the original failed material.

The **Sikadur-Combiflex® SG** system is the second generation development of the globally proven **Sikadur-Combiflex®** with even improved performance such as advanced adhesion properties. The unique system consists of the **Sikadur-Combiflex® SG tape** and the **Sikadur®** adhesives. It is widely used as joint waterproofing in watertight concrete structures.

Advantages:

- Repair of failed joint
- Blocking the path of water penetration
- Increased length of water penetration
- Fully bonded to the concrete preventing underflow
- Waterproofing of joints with extreme movements
- Easy to install and adjust to complicated construction details
- Excellent adhesion to different substrates
- Resistant to high water pressure
- Crack sealing system
- Easy to control and repair





Typical Detail

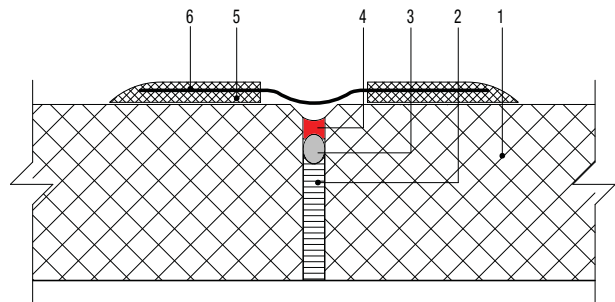

- | | |
|---------------------------------|------------------------------|
| 1. Substrate | 4. Failed sealant |
| 2. Existing compression profile | 5. Sikadur adhesive |
| 3. Existing backing rod | 6. Sikadur-Combiflex SG Type |



Other Typical Problems and Sika Solutions:

- Abrasion and erosion:
Sika® Abraroc or **Sikagard®-820 Abraroc®**
- Chemical attacks (Fatty Acid):
Sikagard®-720 EpoCem® and **Sikagard®-63 N**
- Damaged concrete and steel reinforcement corrosion:
Sika Monotop®-412 NFG
SikaTop® Armatec®-110 EpoCem®

Sika Solutions for Primary Sedimentation Tanks

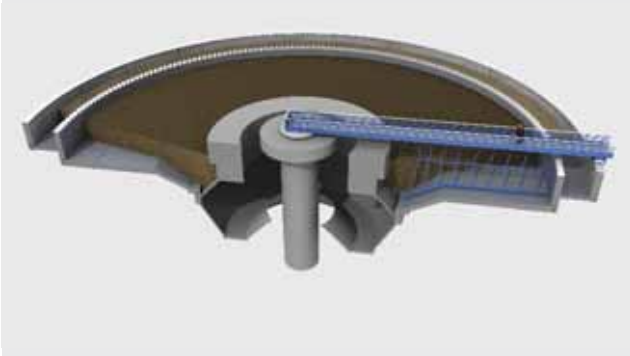

General Description & Main Requirements

In the primary sedimentation tank, sewage flows through large tanks, commonly named “primary clarifiers” or “primary sedimentation tanks”. These tanks are equipped with mechanically driven scrapers that drive the collected sludge towards a hopper.

Typical problems encountered in these tanks are:

- Abrasion and erosion due to sand, grit or other particles.
- Heavy abrasion on the rolling pad of the scrapper.
- Chemical attacks depending on the aggressiveness of the waste or industrial water.
- Leakage and risk of pollution due to cracks, untight joints or damaged concrete.

Sika Solutions for Abrasion Resistant Grout

Mechanical scrapper movement yields to heavy stress combining vibration and abrasion.

Although cost effective, cement based products do not resist much against stress from vibration of the scrapper and therefore do not last long.

Sika proposes for this usage either epoxy or PU based grout/adhesive to fix the metallic rolling cladding on the running surface of the scrapper

Sikadur®-42 HE

- 3-pack epoxy grout
- High early strength and fast curing
- Stress and impact resistant
- High vibration resistance

Sika® Icosit® KC 330 FK

- 2-pack, solvent-free polyurethane adhesive
- High initial adhesion
- Vibration reducing
- Noise absorbing
- Not requiring temporary fixation





Typical Details

1. Concrete wall of clarifier
2. Ground level
3. Water level within the clarifier
4. V2A Stainless steel plate
5. Priming of concrete surface with Primer such as **Sika® Icosit® KC 330** Primer or equivalent
6. Shock absorbing, vibration damping & bonding material such as **Sika® Icosit® KC 330 FK**
7. Priming after grinding the under side of the stainless steel plate with primer such as **Sika® Icosit® KC** Primer or equivalent
8. Scraper bridge

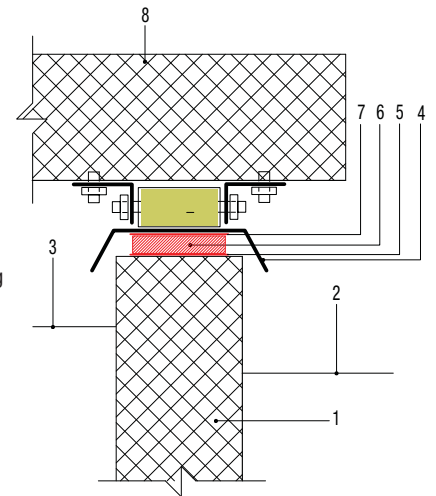

Other Typical Problems and Sika Solutions:

- Chemical attacks and improper waterproofing:
Sikagard®-720 EpoCem® and **Sika® Poxitar F**
- Cracks, untight joints:
Sikadur-Combiflex® SG or **Sikaflex® Pro-3**
- Damaged concrete and steel reinforcement corrosion:
Sika Monotop®-412 NFG
SikaTop® Armatec®-110 EpoCem®
- External concrete protection:
Sikagard®-740 W hydrophobic impregnation
Sikagard®-675 W protective coating

Sika Solutions for Biological Tanks

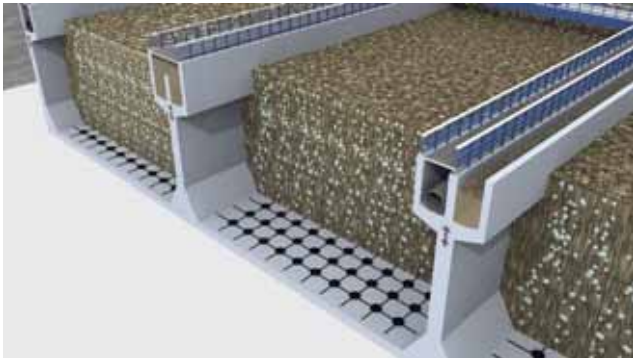

General Description & Main Requirements

These tanks are designed to substantially degrade the biological content of the sewage. These biological contents are originated from human waste, soap and detergents.

Typical problems encountered in these tanks are:

- Chemical attacks depending on the aggressiveness of the waste or industrial water.
- Leakage and risk of pollution due to cracks, untight joints or bad quality concrete.
- Concrete spalling due to reinforcement steel corrosion

Sika Solutions for Concrete Repair

Overview

Repairing damaged concrete is one of the primary requirements in the maintenance of sewage treatment plants. A sound and correctly repaired concrete substrate is also the basic requirement for any additional waterproofing, protection or strengthening systems to be applied.

Requirements

- Full system compatibility (bonding primer, repair mortar, levelling mortar)
- Approved for structural repairs where required (e.g. class R3 or R4 according to EN 1504-3)
- Low crack sensitivity
- Fast and easy application

Sika Solutions

- Bonding primer for large area repairs (where relevant):
SikaTop® Armatec® -110 EpoCem®
- Reinforcement steel bar corrosion protection:
SikaTop® Armatec® -110 EpoCem®
- Semi-fluid repair mortars for large area repairs:
Sika MonoTop®-432 N
- Thixotropic repair mortars for local patch repairs:
Sika MonoTop®-412 N/NFG



- Surface levelling and fairing mortars:
Sika MonoTop®-723 N (normal performance) or
Sikagard®-720 EpoCem® (high performance)
- Self-levelling, epoxy modified, cement based levelling mortars:
Sikafloor®-81/-82 EpoCem®
- Highly resistant to hydraulic abrasion cement based mortar:
Sika® Abraroc® SR or **Sikagard®-820 Abraroc®**

Sika Concrete Repair Expertise

Sika provides an extensive range of thoroughly tested and proven repair materials and systems based on different technologies for each specific requirement and situation.



Typical Detail

1. Host sound concrete
2. Cutting line of damaged concrete, cleaned and prepared substrate
3. Bonding primer (if relevant/required: e.g. **SikaTop® Armatec®-110 EpoCem®**)
4. Corrosion protective coat (e.g. **SikaTop® Armatec®-110 EpoCem®**)
5. Repair mortar (e.g. **Sika MonoTop®-412 NFG**)
6. Smoothing coat (e.g. **Sika MonoTop®-723 N**)

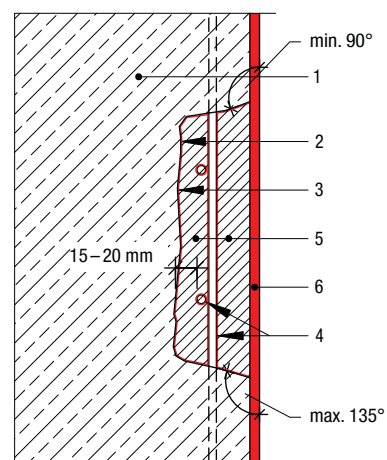

Other Typical Problems and Sika Solutions:

- Chemical attacks and damaged waterproofing:
Sikagard®-720 EpoCem® and **Sika® Poxitar F** or **Sikagard®-63 N**
- Cracks, untight joints:
Sikadur-Combiflex® SG, **Sikaflex® Pro-3**
- External concrete protection:
Sikagard®-740 W hydrophobic impregnation
Sikagard®-675 W protective coating

Sika Solutions for Gasometers

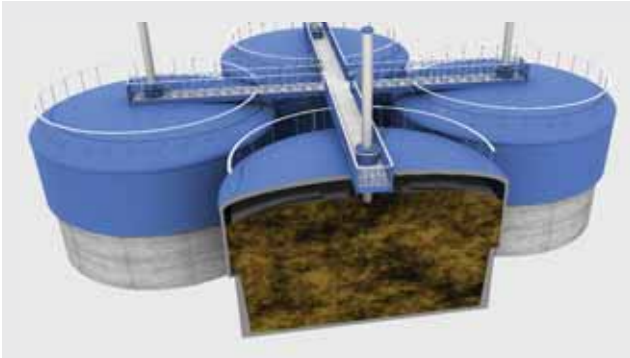

General Description & Main Requirements

Within the process of biological deterioration in the biological tank or the digestion tank, biogas (methane, CO₂) will be produced and be stored in gasometers. These gasometers are generally built in steel. Biogenic sulfuric acid is highly aggressive to steel. Additional stresses is caused by the elevated temperature.

Typical problems encountered are:

- Steel corrosion
- Leakage and risk of pollution due to untight joints

Sika Solutions for Steel Corrosion

Sika provides a large range of extensively tested products in the field of corrosion protection. Sika offers products for the protection of new structures on site or for shop application. For maintenance works we offer a surface tolerant primer allowing application of the corrosion protection without sandblasting the surface, meaning no plant shut down is necessary. UV-resistant top coats, available in almost all RAL colour shades, give the possibility for aesthetic designs.

Sika Solutions for Digesters, Gasometer and BSA (Biogenic Sulphuric Acid) Corrosion

- Hot spray Polyurea, solvent free, crack bridging, highest chemical resistance, 1 layer application:
Sikalastic®-844 XT, on primer **SikaCor® EG 1** (on steel)
- High performance epoxy resin, solvent based, 3 layer application:
Sika Permacor®-3326 EG H, directly applied on blasted steel

Sika Solutions for Steel components

Steel, not subject to BSA:

- Standard epoxy, solvent free, high chemical resistance, 3 layer application
Sikagard®-63 N
- Epoxy, athracene oil based, high solid
Sika® Poxitar F



Sika Solutions for Structural Steel Work

Coating systems for structural steel have to fulfil the requirements in accordance to EN ISO 12944:

- System build up for corrosive industrial and maritime climate based on 2-comp. products
SikaCor® EG-System
- System build up for maintenance:
Sika® Poxicolor Primer HE



Typical Detail

1. Steel plates
2. Bolt with protection
3. **Sikaflex® TS Plus**

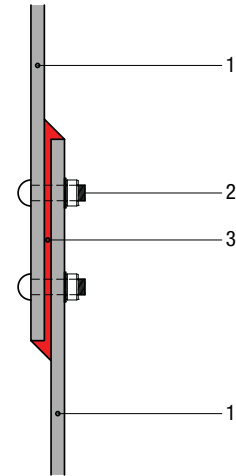

Other Typical Problems and Sika Solutions:

- Steel plate Joint:
Sikaflex® TS Plus
- External weathening protection:
Concrete structures:
Sikagard®-740 W
Brick structures:
Sikagard®-703 W

Sika Solutions for Digestion Tanks

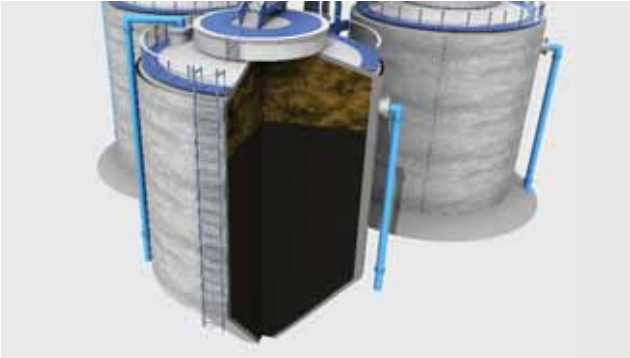

General Description & Main Requirements

The sewage sludge digestion tank is where the sludge is stabilized, reduced in volume, made innocuous through the process of dissolving organic substance with the help of anaerobic bacteria and energy is recovered.

Typical problems encountered are:

- Heavy chemical attacks above the anaerobic zones
- Leakage and risk of pollution due to cracks, untight joints or damaged concrete.

Sika Solutions for Heavy Chemical Protection

Concrete or steel above the sludge may suffer heavy attack due to the formation of the sulphuric acid (refer to page 13 for more details) Additional stress is caused by the elevated temperature originating from the biological process.

Down times always create problems and difficulties for the owners, as well as loss of money. Sika offers solvent free, high build coating systems which can be applied in one layer on a good prepared surface. So down times can be minimised without the reduction of the protective properties.

Sikalastic®-844 XT on primer

Sikafloor®-156/-161 on concrete

- Hot spray Polyurea
- Solvent free
- Crack bridging
- Highest chemical resistance
- 1 layer application

Sika Permacor®-3326 EG H

- High performance epoxy resin
- Solvent based
- 3 layer application

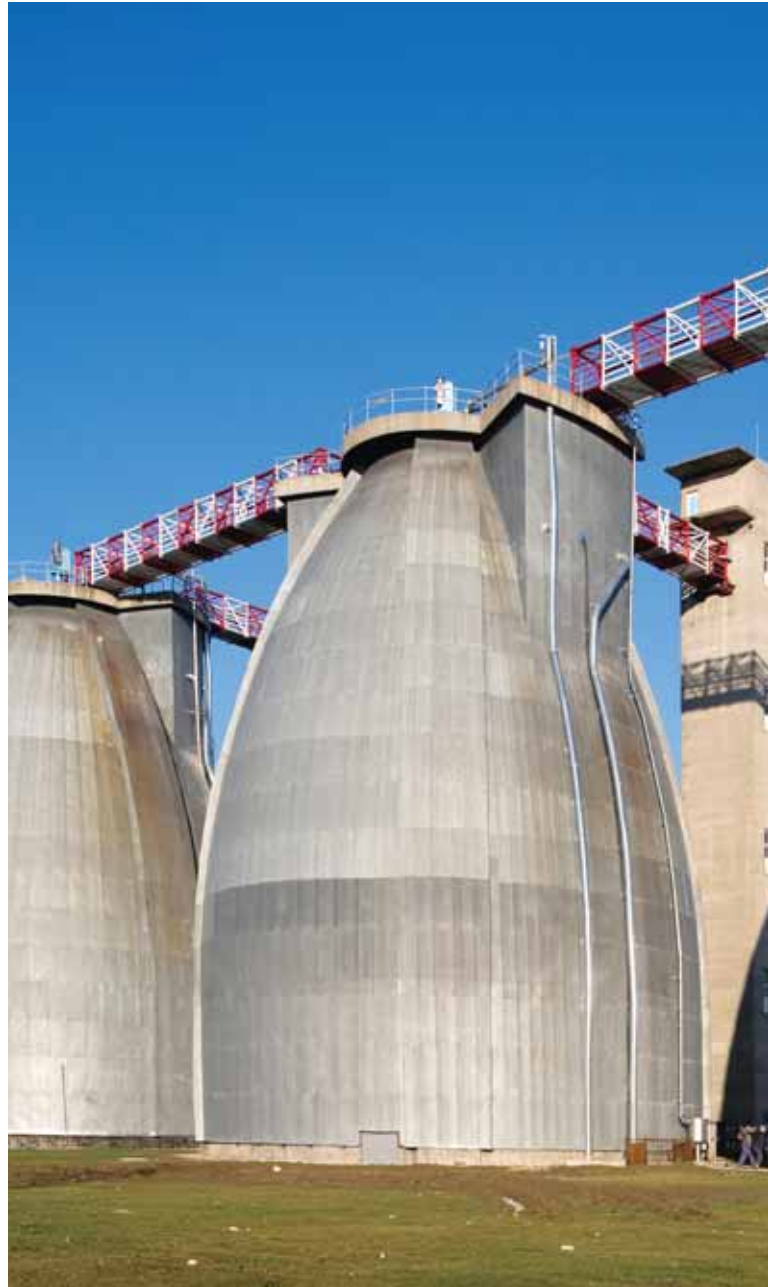



Typical Detail

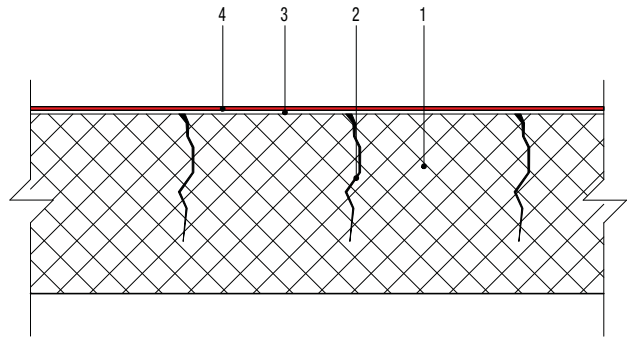

1. Concrete
2. Cracks
3. Primer **Sikafloor®-156/-161** lightly broadcasted with quartz sand 0.3 – 0.8 mm
4. 1 x **Sikalastic®-844 XT**



Other Typical Problems and Sika Solutions:

- Cracks, untight joints:
Sikadur-Combiflex®, **Sikaflex® Pro-3**,
Sikaflex® TS Plus
- Damaged concrete and steel reinforcement corrosion:
Sika Monotop®-412 NFG
SikaTop® Armatec®-110 EpoCem®
- External concrete protection:
Sikagard®-740 W hydrophobic impregnation
Sikagard®-675 W protective coating

Sika Solutions for Filtration Beds



General Description & Main Requirements

In the filtration bed, the treated water flows through various layers of sand beds for final filtration before being discharged in the environment.

Filters are periodically cleaned using air and clean water at counter stream. The cleansing water is then pumped back to the aeration basin for retreatment.

Typical problems encountered are:

- Abrasion
- Damaged waterproofing
- Leakage and risk of pollution due to cracks and untight joints

Sika Solutions for Blistering

Typical problems occurring in sewage treatment plants, are the formation of blisters when semi permeable coatings are applied in water saturated concrete.

This can be avoided using as pore sealer **Sikagard®-720 EpoCem®** when during the repair works.

This specially developed product acts as temporary moisture barrier allowing the application of a coating or flooring to a green or damp concrete. The advantage to the owner is reducing completion time and eliminating the risk of blistering.

Other characteristics of **Sikagard®-720 EpoCem®** are:

- Internal curing – no curing required
- Quick over-coating with resin coatings – either water or solvent based
- Increased chemical resistance (comparatively to polymer modified cement based product)





Coving Detail

1. Concrete substrate
2. **Sikagard®-720 EpoCem®**
3. Construction joint
4. **Sika MonoTop®-412 N**

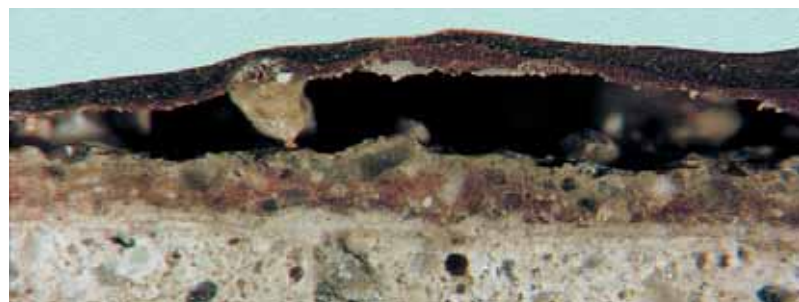
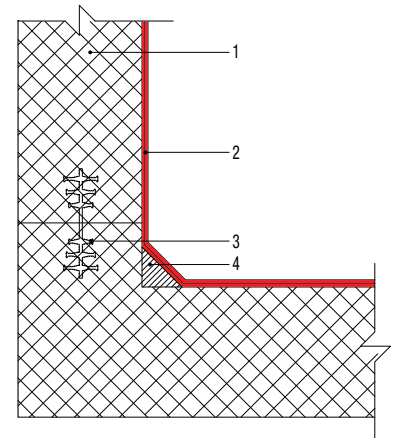

Other Typical Problems and Sika Solutions:

- Damaged waterproofing:
Sikagard®-720 EpoCem®
- Abrasion:
Sika® Abraroc® SR or **Sikagard®-820 Abraroc®**
- Cracks, untight joints:
Sikadur-Combiflex® SG, Sikaflex® Pro-3

Sika Solutions for Secondary Sedimentation Tanks

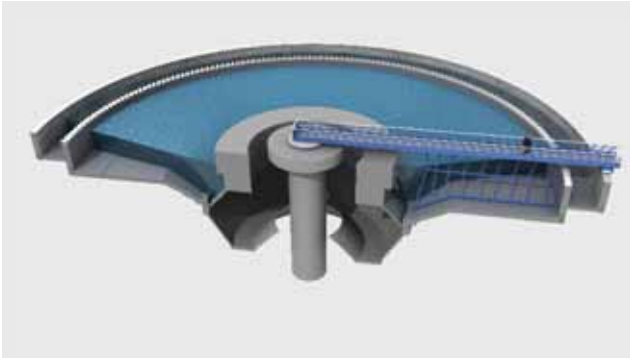

General Description & Main Requirements

Secondary treatment is intended to degrade further the organic content of sewage water originating from human waste, soap, detergent, etc. Most of the plants treat the sewage using aerobic biological processes.

Typical problems encountered are:

- Erosion due to water flow
- Chemical attacks, depending on the aggressiveness of the waste water
- Leakage and risk of pollution due to cracks, untight joints or damaged concrete
- Steel reinforcement corrosion due to reduced concrete cover

Sika Solutions for Durable Joint Sealants

Sealants used in sewage treatment plants have to survive extremely harsh conditions and thus must meet very demanding requirements.

Sikaflex® Pro-3

1-component non-sag sealant

- High resistance against waste water and waste water treatment chemicals
- Excellent adhesion under permanent water immersion
- Resistance against microbiological attack
- Resistance against continuous high water pressure

Approvals & standard

- ISO 11600 25 HM, EN 15651, part 4 25 HM CC
- CSM: Very good resistance against mould and bacteria growth according to IPA (ISO 846)
- Waste water resistance according to the DIBt guidelines (German approval body for construction products and types of construction)

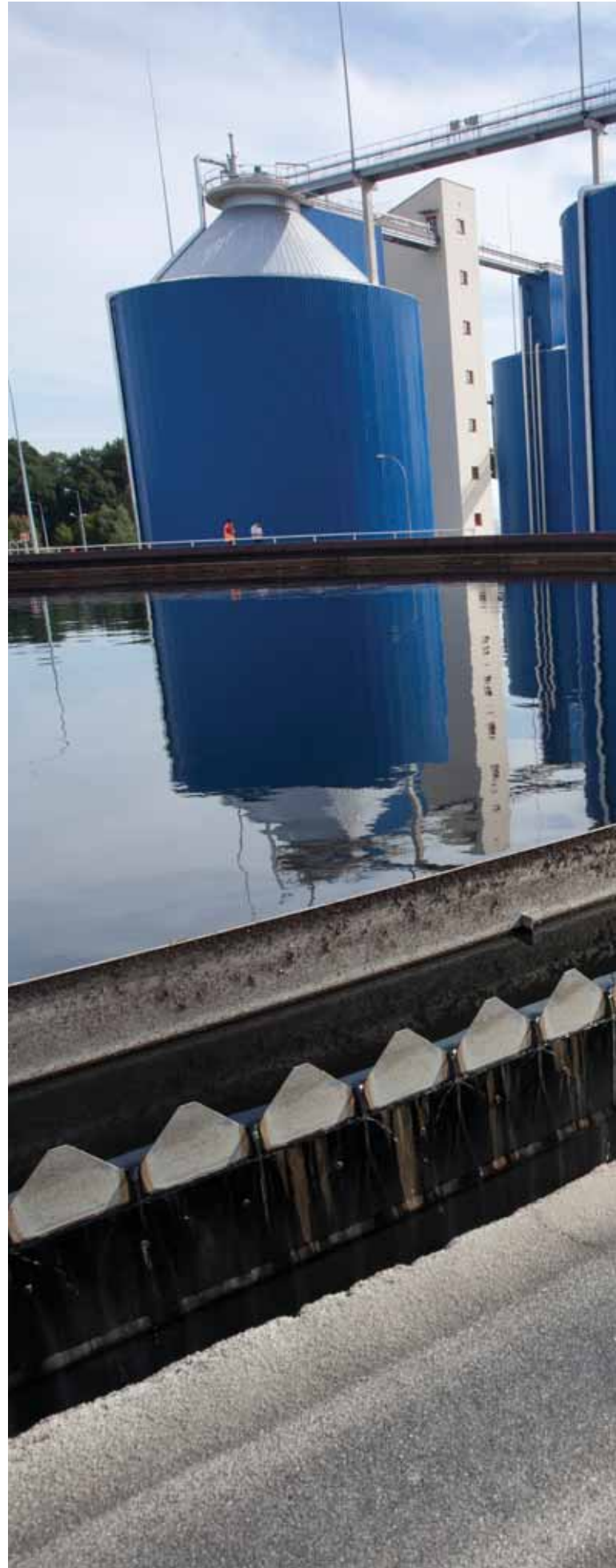



Typical Detail for Construction Joint

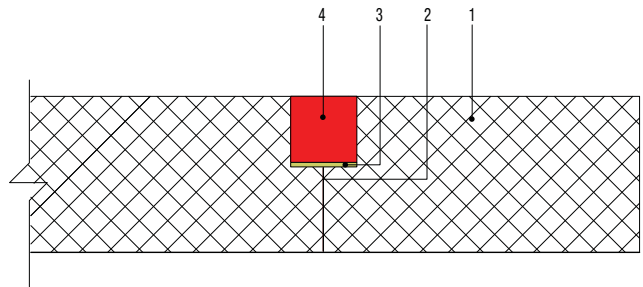

- 1. Substrate
- 2. Construction joint
- 3. Bond breaking
- 4. **Sikaflex® Pro-3**



Other Typical Problems and Sika Solutions:

- Chemical attacks and improper waterproofing:
Sikagard®-720 EpoCem® and **Sika® Poxitar F**
- Cracks, untight joints:
Sikadur-Combiflex®, **Sikaflex® Pro-3**,
Sikaflex® TS Plus for Steel
- Damaged concrete and steel reinforcement corrosion:
Sika Monotop®-412 NFG
SikaTop® Armatec®-110 EpoCem®

Sika Solutions for Technical Service Buildings and Weathering Protections

General Description & Main Requirements

Most WWTP has a technical service building. External surfaces of the building as well as of the above ground tanks are exposed to weathering and often need protection.

In these technical building, chemicals are handled. Therefore the floors in the chemical storage area also need protection.

Sika Solution for Floors

- Epoxy flooring, self levelling, solvent free, high chemical resistance:
Sikafloor®- 381
- PU-modified cementitious flooring, solvent free, excellent chemical resistance, lightly slip resistant:
Sikafloor®-21 PurCem

Sika Solutions for External Surface Protection

- Surface applied corrosion inhibitor:
Sika® FerroGard®-903+
- Thixotropic hydrophobic impregnation for concrete:
Sikagard®-706 Thixo
- Hydrophobic impregnation for concrete:
Sikagard®-740 W
- Hydrophobic impregnation for bricks and other mineral substrates:
Sikagard®-703 W
- Concrete protective coating:
Sikagard®-675 W
- Crack bridging concrete protective coating:
Sikagard®-550 W





Typical Detail

Sikafloor® Coating Connection on Drainage Channel or Outlet

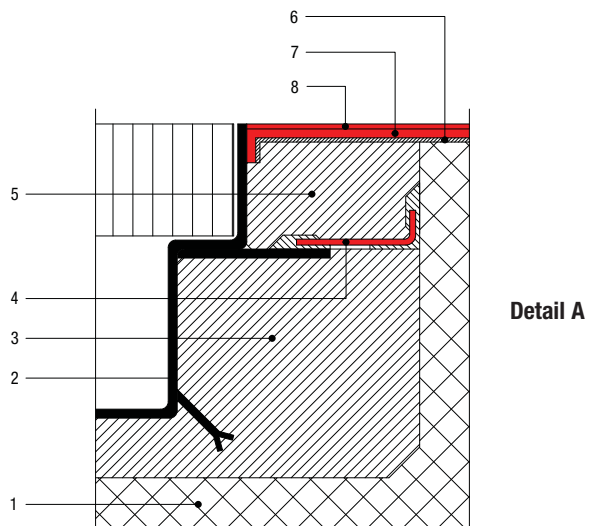
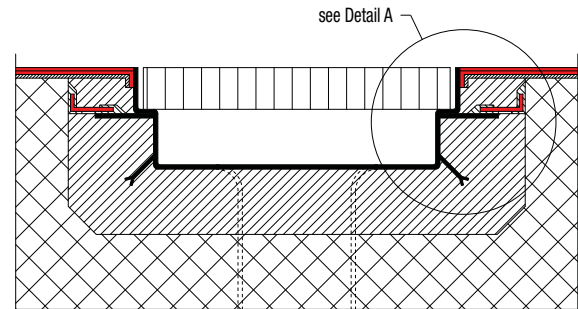

1. Concrete slab
2. Drainage channel or outlet with adhesive steel flange
3. **SikaGrout®** anchorage mortar
4. Sealing adhesive steel flange with **Sikadur-Combiflex® System**
5. **SikaGrout®** anchorage mortar
6. **Sikafloor®** Primer (epoxy) thickness ca. 0.1 mm
7. **Sikafloor®** coating in epoxy or PUR thickness ca. 2.0 – 4.0 mm
8. **Sikafloor®** finishing thickness ca. 0.1 – 0.4 mm according to the selected coating system and the mechanical load anticipated in service



Other Typical Problems and Sika Solutions:

Roofs in the buildings (technical and office) of the sewage treatment plants may require waterproofing. Sika offers full range of roof waterproofing that fits the different needs of owner:

- **SikaPlan® PVC** or **FPO** membrane
- **SikaLastic®** liquid applied membrane

Other Sika Solutions

General Description & Main Requirements

In sewage water treatment plant, additionally to the different problems exposed in the previous pages, sometimes special issues are raised such as strengthening of a basin, anchoring some ladders in a tank, making an opening for a new pipe, waterproofing the flat roof of a new building, etc. Sika as specialist producer have solutions for each specific needs of a project.

Sika Solutions for Structural Strengthening

Due to design errors, upgrading of a structure or damaged of the concrete substrate, structural strengthening of a structure may be necessary. Bonding of strengthening products to an existing structure can extend its lifetime significantly avoiding demolition and rebuilding. Structural strengthening by bonding of external plates or lamination of fabrics is carried out in accordance with relevant design codes. The surfaces where the externally bonded reinforcement will be installed must be prepared and cleaned thoroughly. Any damages or deteriorated concrete must be removed and repaired to comply with EN 1504 part 10 section 7.2.4 and section 8. Depending on the project, different solutions are available:

Sika® CarboDur plates

- Pre-cured CFRP plates
- Bonded with **Sikadur®-30** adhesive
- Light weight and easy to install, especially overhead
- Very high strength
- Excellent durability and fatigue resistance
- Minimal preparation, applicable in several layers
- Can alternatively be embedded into the substrate

SikaWrap® Fabrics

Dry fibre fabrics, saturated on site

Laminated with **Sikadur®-330** or **Sikadur®-300** resin

- Available in different weights and widths
- Flexible and accommodating of different surface planes and geometry
- Multifunctional material for use in different strengthening applications

Others:

CarboStress® system: Post-tensioning of plates for active strengthening

CarboShear L: Profiles for shear strengthening of beams

CarboHeater: Accelerated curing of **Sikadur®-30** adhesive



Sika Solutions for Grouting

SikaGrout®-314

- High performance shrinkage compensated cementitious grout
- CE market as EN 1504-6, anchoring of reinforcement bars
- Low shrinkage, high mechanical strength
- Grouting under base plates, machine bases etc.
- Fast strength development



Typical Details

1. Concrete substrate
2. **Sika® AnchorFix-1, 2 or 3**
3. Leveling mortars **Sikadur®-41**

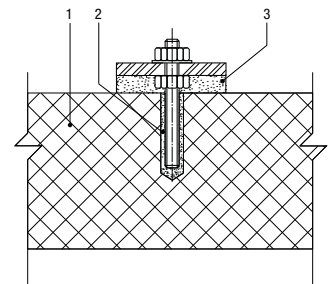
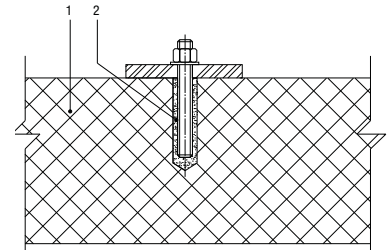

Sika Solutions for Anchoring

Sika® AnchorFix-2

High performance, solvent and styrene-free epoxy acrylate based two part anchoring adhesive

- ETA 001 for M(& M24 (embedment depths of 8 to 12D), CE marked for Zinc plated studs, steel grade, SSA4 70/80 and HCR steel.
- ETA 001 TR023 for post installation of rebar connections (shallow embedment)
- Fire approval for threaded and reinforcement bars

Sika® AnchorFix-3+

High performance, two part solvent free epoxy based anchoring adhesive

- Conforms to ETA 001 for threaded rods
- CE marked as En 1504-6, anchoring or reinforcement bars
- Outstanding chemical resistance to sulphuric acid, ammonia and sodium hydroxide solution

Sika® AnchorFix-1

Fast curing, solvent and styrene-free based 2-part polyester anchoring adhesive

- ETA 029 for masonry use

Sika Solutions for New Construction

Concrete for Sewage and Waste Water Treatment Plants

Reinforced concrete forms the load-bearing framework, floors and walls for practically all of the specialist structures in sewage and waste water treatment plants. These include all of the drainage channels and pipework into the plant and between the different processes including initial mechanical screening and separation, primary sedimentation tanks, secondary treatment including clarification in aeration / biological digestion tanks, and finally any tertiary specialist chemical treatments and purification that are required.

High performance durable concretes must be used for these structures, particularly for direct contact with the sewage and waste water. However it should be clearly understood that concrete alone cannot withstand all of the different types and degrees of mechanical and chemical attack that can be imposed in a waste water treatment plant. The correct design and construction of these structures, together with the additional surface protection systems required, are therefore all essential for long term durability. Correct maintenance and the timely scheduling of this is also necessary.

The main technical challenge for concrete is to resist these environments.

Concrete Corrosion & Erosion:

- Mechanical abrasion & erosion
- Freeze-thaw attack, with or without de-icing salts
- Chemical attack (acid and sulfate attack)
- Alkali-aggregate reaction (ASR)

Depending on the degree of exposure, the concrete can be designed and placed to provide increased levels of resistance, or this can be further increased by the application of a suitable protective surface treatment. The so-called 'tidal zones' of tanks and structures which are areas continuously alternating between dry and wet exposure due to variations in water levels, are particularly at risk. In these zones the damage processes can be accelerated by the alternating high oxygen and high water / chemical exposure. Over time, in some structures an organic "protective barrier layer" is formed on the concrete surfaces; however, each time this layer is removed by the cleaning scrapers, the concrete surface can also be abraded and is gradually eroded. The operation of the plant must therefore be optimised to minimize damage from this process.

Where the concrete surfaces are to be exposed, it is always important to pour and place the concrete as dense as possible, with minimal voids or surface cracking, plus:

- High ASR resistance is achieved through modifying the cement binder by adding suitable quantities of pulverised fly ash (PFA), or ground-granulated-blast-furnace-slag (GGBFS).
- Increased resistance to freeze-thaw action is obtained by adding air entraining agents.



- High resistance to mechanical impact and abrasion is achieved using a low water/cement ratio and added silica fume.

Chemical resistance is related to the impermeability and density of the surface and the cement matrix, so a low w/c ratio and closed finish is necessary. However against aggressive chemicals, particularly strong acid attack, the resistance of concrete alone is limited and so an additional protective surface treatment must be applied.



Typical Detail

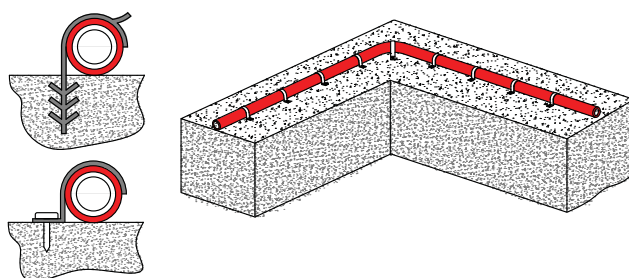

No matter how good a concrete is, the failure will occur at points of weakness; construction joints, cold joints and expansion joints, pipe penetrations, fixing, etc.

Sika since decades provides a wide range of solutions to cater for all types of detailing: **Sika® Waterbar** for construction and expansion joints, **Sikaflex® Pro-3** a chemical resistant joint sealant, **SikaFuko®** Hose re-injectable hoses for construction joints, **Sikadur-Combiflex® SG** system for sealing construction joints, failed sealants, cracks etc.

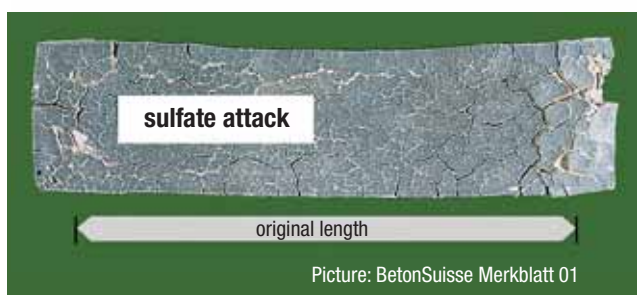

Picture: BetonSuisse Merkblatt 01

Sulfate driven attack is caused primarily by sulfates dissolved in water. By reacting with the hardened cement matrix, an increase in volume is induced which damages the structure.



Picture: BetonSuisse Merkblatt 01

Acidic attacks which dissolve calcium compounds out of the hardened cement matrix can be caused by acids, exchangeable salts, vegetable, animal fats or oils. Degradation of the concrete usually occurs very slowly.

Case Studies

Sewage Plants Al Wathba and Al Saad, Abu Dhabi



Project Description

The ADWEA sewage project consist of two new build sewage treatment plants in Abu Dhabi, (Al Wathba and Al Saad plant). These two main sewage plants receive approx. 95% of the sewage from Abu Dhabi and Al Ain Cities. The sewage is delivered from substations all around the area.

Project Requirements

Main requirements are the chemical resistance to sewage, crack bridging properties, mechanical resistance, waterproofing, suitable floorings, also electrically conductive floors and long lasting joint sealing materials. 36 Sika products have been approved for use in the project.

Sika Solution

The anaerobic digester tanks have been internally lined with **Sikalastic®-844 XT**. Pump stations and settlement tanks have been protected with a glass fibre reinforced system **Sikagard®-63 N**. The protection in the aeration and effluent tanks has been executed with **SikaTop® Seal-107**, reinforced with a glass fabric. Floors in the substations and the workshops have been protected with **Sikafloor®-264** and **Sikafloor®-325** on primer **Sikafloor®-161**. The electric rooms have been covered with **Sikafloor®-262 AS**.

İski İkitelli Water Treatment Plant, Istanbul, Turkey



Project Description

This is a large sewage water treatment plant with capacity to provide water to 5'200'000 people, 40% of the population in Istanbul. It has 2 separate water treatment systems, which provide 840.000 m³ of clean water a day. System 1 was completed in 1998 and system 2 in 2003.

Project Requirements

The sewage treatment plant treats waste water containing the biological contamination and eutrophication. It needs to use various procedures and chemicals to make the water finally clean before going back to the city's water supply system. The water containing structures has to survive under extremely severe conditions and resist against micro-biological and chemical attack.

Sika Solution

Concrete spillings were repaired using **Sika MonoTop®** polymer modified patch repair mortar. Concrete was protected against chemical aggression with first a primary application of **Sikagard®-720 EpoCem** as temporary moisture barrier, followed by **Sikagard®-2040 TR** chemical resistant epoxy coating. Jointing of concrete elements were done with the chemical resistant sealant **Sikaflex® Pro 3**

Wrocław Waste Water Treatment Plant, Poland



Project Description

The sewage treatment plant in Wrocław is a mechanical-biological sewage treatment plant with chemical-assisted removal of phosphorus and full sludge processing.

The goal of the third phase of development and modernization of the sewage treatment plant was to increase the capacity from an average of 70 000 to 140 000 m³/d per day, and to fulfill more stringent standards of water leaving the plant and entering the river stream.

Project Requirements

Settlement tanks and sludge pump stations needed to be rehabilitated. New structures needed to be built like grit chambers, primary and secondary settlement tanks, digestion chambers, sludge dehydration buildings and biomass tanks.

Sika Solution

Sika could provide a technical solution for the following applications:
Preliminary and secondary settlement tank walls:

Sika® Repair-30 F – Repair mortar and **Sika® Poxitar F** – epoxy coating (3 layers)

Preliminary and secondary settlement tank floor:

Sikafloor® 156 – epoxy levelling mortar and **Sika® Poxitar F** – epoxy coating (3 layers)

Top of tanks and driving range:

Sika® Elastomastic TF – 3 mm highly mechanical and chemical resistant epoxy polyurethane hybrid and **Sikaflex® PRO 3** – chemical resistant polyurethane sealant

Pumping Station:

Sika® Repair-30 F – as levelling mortar and **Sika® Poxitar F** – epoxy coating (3 layers)

Digestion chambers:

Sika® Repair-30 F – as levelling mortar and **Sika® Poxitar F** – epoxy coating (3 layers – laminated)

Sindelfingen-Böblingen WWTP, Germany



Project Description

This plant belongs to the community towns of Sindelfingen and Böblingen. This WWTP alone treats over 15 millions cubic meter of waste water annually.

The plant boasts efficient treatment of the waste water. For organic pollutants a purification rate of over 90% is achieved and at the same time more than 70% of dissolved nutrients including phosphorus and nitrates are removed from the water.

Project Requirements

The two primary settlement tanks and the mechanical scrapper tracks were in need of immediate refurbishment.

Concrete under the settlement tanks was suffering from decays.

The mechanical scrapper tracks were subjected to heavy abrasion. Exposed steel structures were corroding.

Sika Solution

Sika could provide a technical solution for each application:

Settlement tanks:

Concrete repair:

Sika MonoTop®-601 Neu – exposed steel protection

Sika MonoTop®-602 / 603 Neu – Polymer modifier repair mortar

Sika® Icoment®-520 – Resurfacing mortar and **Sika® Poxitar® F** – Chemical protection

Scrapper track refurbishments:

Sikafloor®-156 – Epoxy primer, **Sika® Elastomastic® TF**

– wear resistant, crack bridging polyurethane epoxy resin and

Sikafloor®-359 – abrasion resistance polyurethane sealer coat

Steel work:

SikaCor®-EG System – primer, epoxy intermediate coat and polyurethane top coat

Sika Full Range Solutions for Construction

Concrete Production



Sika® ViscoCrete®
Sika® Retarder®
Sika® SikaAer®

Waterproofing



Sikaplan®, Sikalastic®
Sika® & Tricosal® Waterstops
Sika® Injection Systems

Flooring



Sikafloor®
SikaBond®

Corrosion and Fire Protection



SikaCor®
Sika® Unitherm®

Concrete Repair and Protection



Sika® MonoTop®
Sikagard®
Sikadur®

Structural Strengthening



Sika® CarboDur®
SikaWrap®
Sikadur®

Joint Sealing



Sikaflex®
Sikasil®

Grouting



Sikadur®
SikaGrout®

Roofing



Sarnafil®
Sikaplan®
SikaRoof® MTC®

Also Available from Sika



Sika Services AG

Tüffenwies 16, CH-8048 Zurich
 Switzerland
 Phone +41 58 436 40 40
 Fax +41 58 436 41 50
www.sika.com

Our most current General Sales Conditions shall apply.
 Please consult the Product Data Sheet prior to any use and processing.

