

Senergy[®]



Senturion I System

Typical 2D Details

BUILDING TRUST



Senturion I System

Typical 2D Details

Table of Contents

- | | |
|--|--|
| 1. Application (Plan View) | 18. Pipe Penetration |
| 2. Application (Isometric) | 19. Light Fixture |
| 3. Aesthetic Reveal | 20. Dryer Vent |
| 4. Insulation Board and Reinforcing Mesh at Openings | 21. Termination at Top of Deck |
| 5. Clad Window Jamb w/ Band | 22. Termination at Bottom of Deck |
| 6. Clad Window Head w/ Band | 23. Termination at Foundation w/ Flashing |
| 7. Clad Window Sill w/ Band | 24. Termination at Foundation w/ Starter Track |
| 8. Clad Window Jamb | 25. Termination at Brick w/ Drainage |
| 9. Clad Window Head | 26. Termination at Brick w/ Sealant |
| 10. Clad Window Sill | 27. Kick-Out Flashing at Sloped Roof |
| 11. Primed Window Jamb | |
| 12. Primed Window Head | |
| 13. Primed Window Sill | |
| 14. Expansion Joint at Floor Line | |
| 15. Expansion Joint at Change in Substrate | |
| 16. Termination at Soffit or Gable | |
| 17. Downspout | |

Notes:

- **The details within are the latest recommendations and are represent in good faith by Sika Corporation US (hereinafter Sika). The details are subject to change without notice. Sika accepts no liability for the end use of the details. For conditions not shown, consult Sika for review of specific details.**
- **Install Sika materials in accordance with current installation instructions.**
- **Unsatisfactory conditions shall be reported to the General Contractor and corrected before the application of Sika products.**

Senturion I System

TYPICAL APPLICATION (PLAN VIEW)

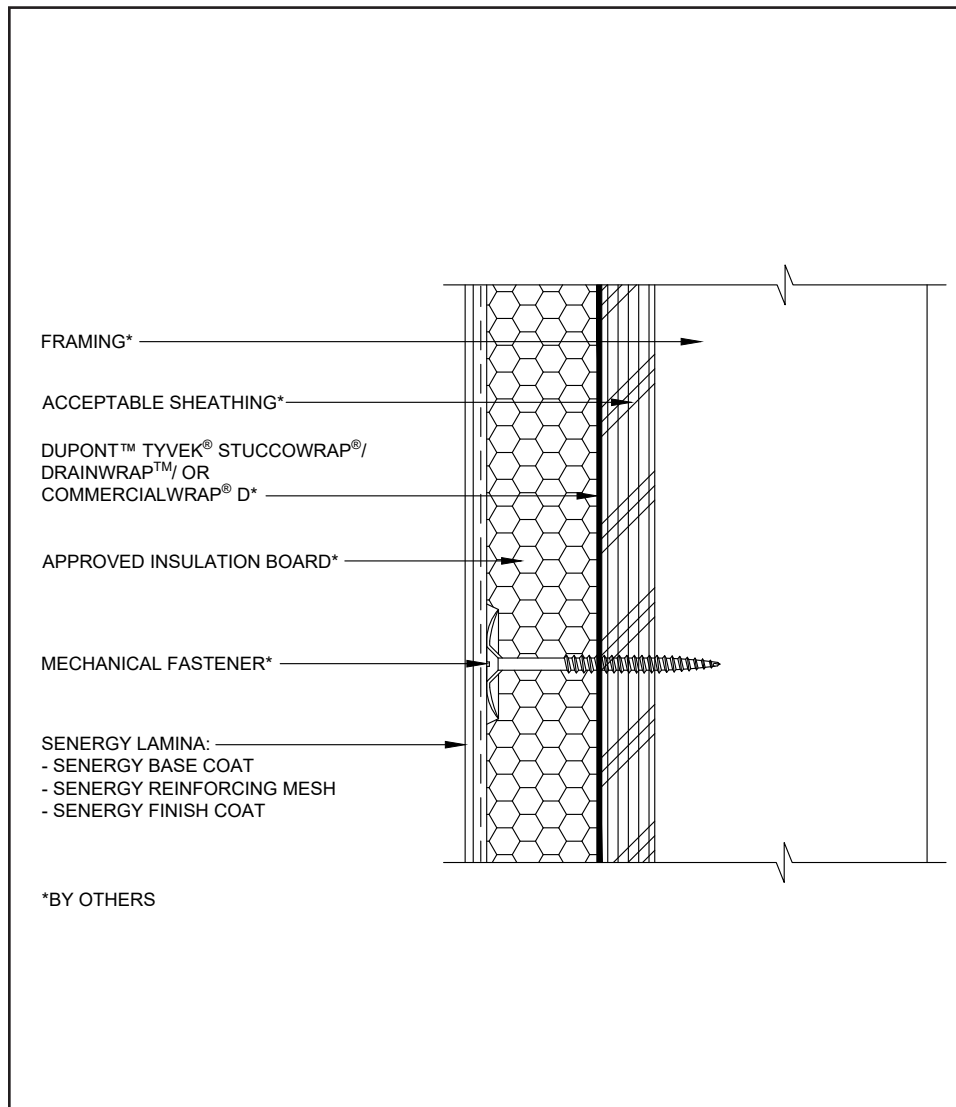

- Acceptable water resistive barriers
 - Dupont™ Tyvek® StuccoWrap®
 - Dupont™ Tyvek® DrainWrap™
 - Dupont™ Tyvek® CommercialWrap® D

01 0524

(*NOTE: BY OTHERS)

The details within are the latest recommendations and are represented in good faith by Sika Corporation US (hereinafter Sika). The details are subject to change without notice. Sika accepts no liability for the end use of the details. For conditions not shown, consult Sika for review of specific details.

- Install Sika materials in accordance with current installation instructions.
- Unsatisfactory conditions shall be reported to the General Contractor and corrected before the application of Sika products.

Senturion I System

TYPICAL APPLICATION (ISOMETRIC)

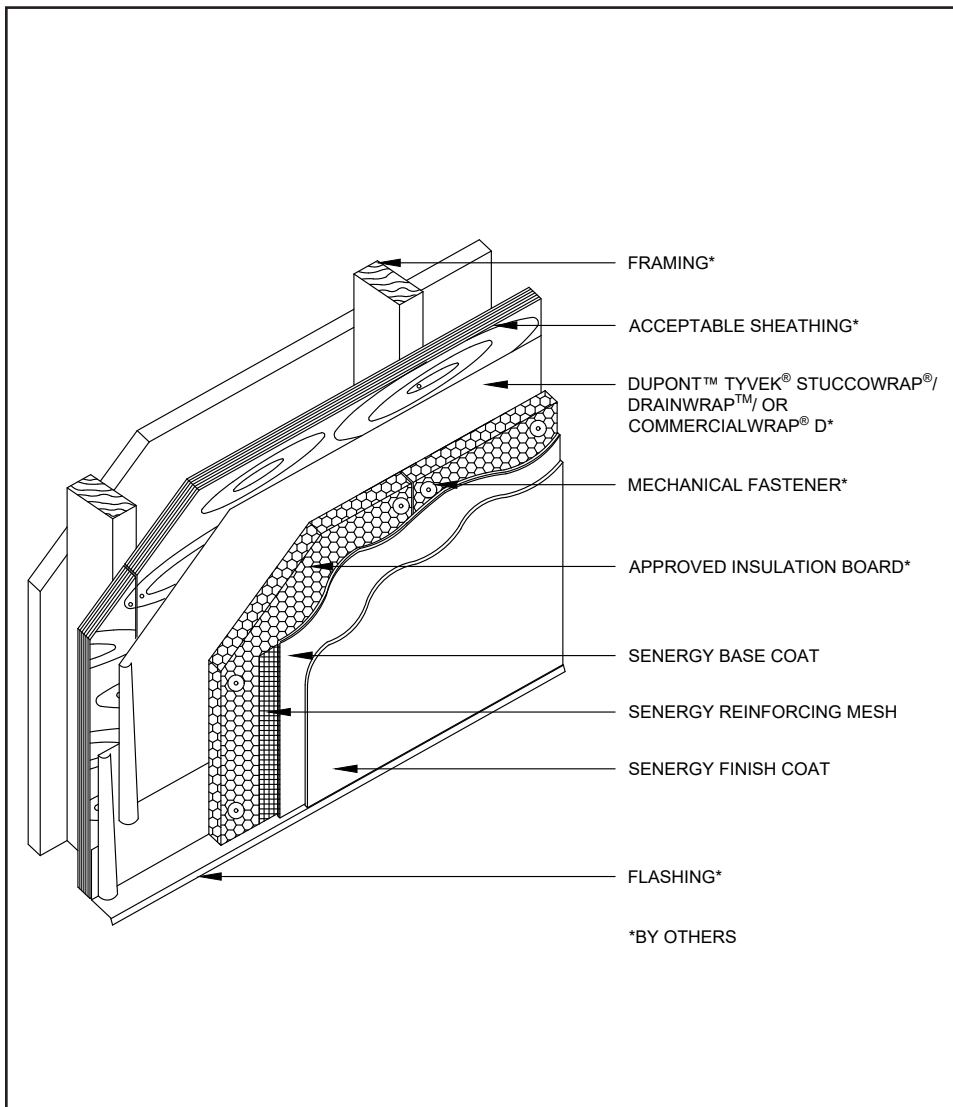

- Acceptable water resistive barriers
 - Dupont™ Tyvek® StuccoWrap®
 - Dupont™ Tyvek® DrainWrap™
 - Dupont™ Tyvek® CommercialWrap® D

02 0524

(*NOTE: BY OTHERS)

The details within are the latest recommendations and are represented in good faith by Sika Corporation US (hereinafter Sika). The details are subject to change without notice. Sika accepts no liability for the end use of the details. For conditions not shown, consult Sika for review of specific details.

- Install Sika materials in accordance with current installation instructions.
- Unsatisfactory conditions shall be reported to the General Contractor and corrected before the application of Sika products.

Senturion I System

TYPICAL AESTHETIC REVEAL

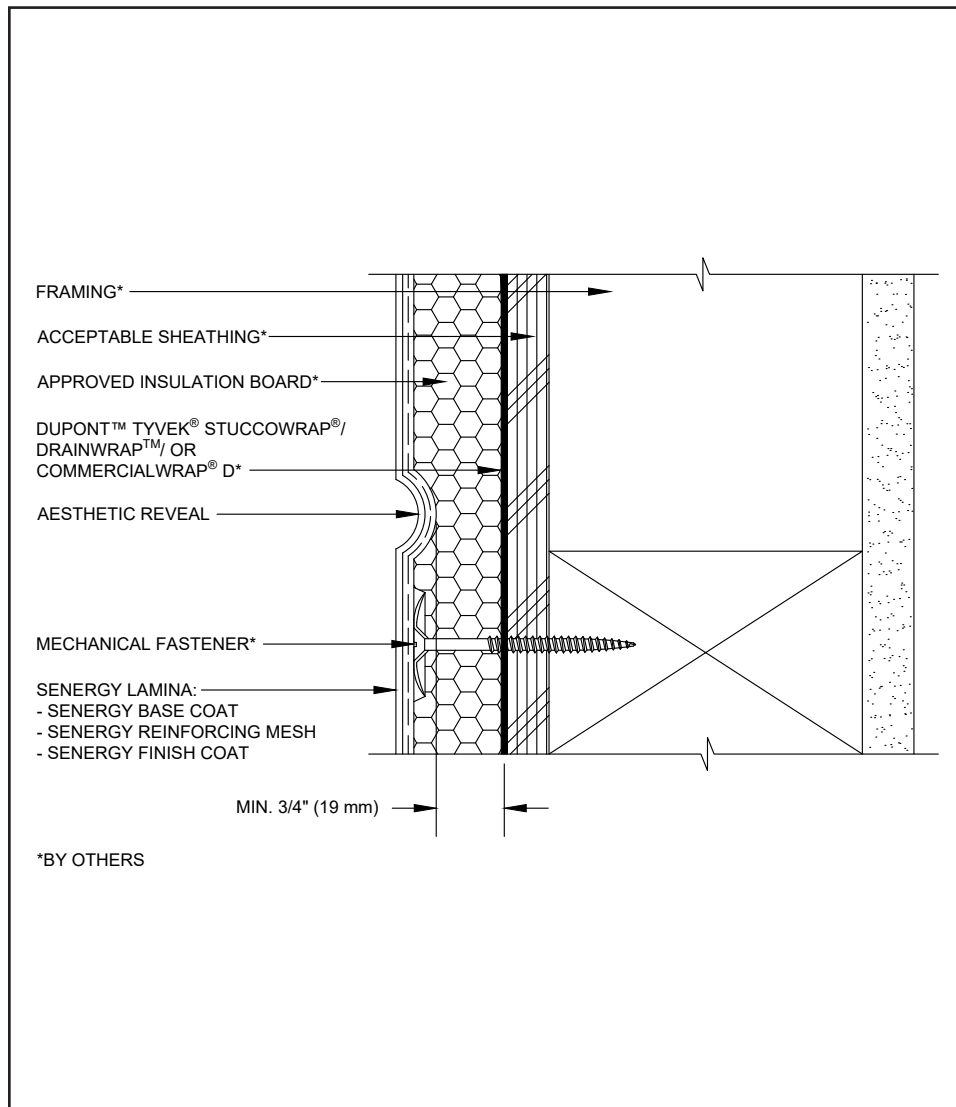

- Maintain a continuous layer of EPS insulation board, at a minimum 3/4" (19 mm) thickness, behind all reveals and aesthetic grooves.
- Reinforcing mesh shall be continuous and care shall be taken to ensure reinforcing mesh is not cut during base coat application.
- Horizontal reveals shall provide for outward positive drainage.
- Reveals must not occur at the abutment of two pieces of EPS insulation board.

03 0524

(*NOTE: BY OTHERS)

The details within are the latest recommendations and are represented in good faith by Sika Corporation US (hereinafter Sika). The details are subject to change without notice. Sika accepts no liability for the end use of the details. For conditions not shown, consult Sika for review of specific details.

- Install Sika materials in accordance with current installation instructions.
- Unsatisfactory conditions shall be reported to the General Contractor and corrected before the application of Sika products.

Senturion I System

TYPICAL INSULATION BOARD AND REINFORCING MESH AT OPENINGS

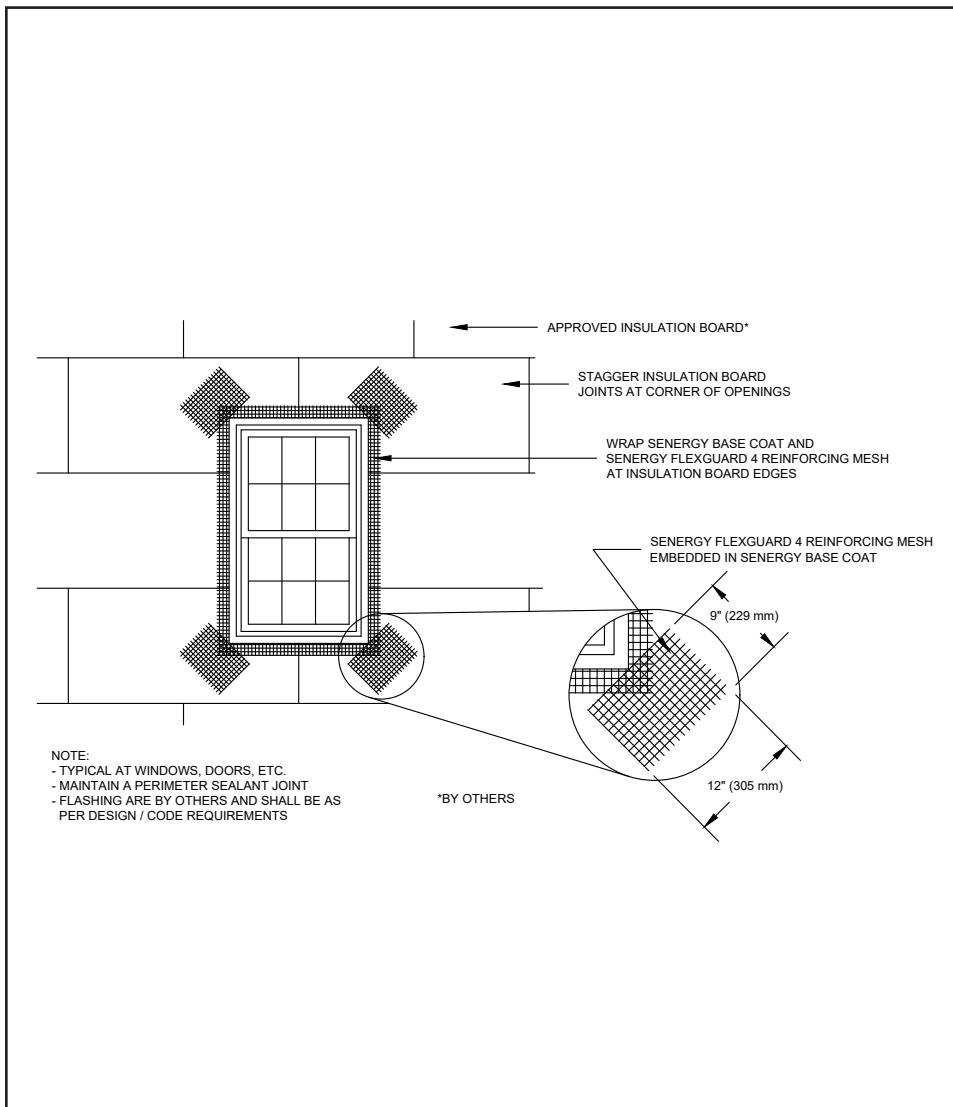

- Stagger joints horizontally in a running bond pattern offset a minimum of 6".
- Pre-cut insulation board to fit openings and projections. Insulation board must be a single piece around corners of openings.
- Stagger vertical joints and corners. Stagger insulation and sheathing board joints.
- Offset insulation board joints from sheathing joints by a minimum of 16".

04 0524

(*NOTE: BY OTHERS)

The details within are the latest recommendations and are represented in good faith by Sika Corporation US (hereinafter Sika). The details are subject to change without notice. Sika accepts no liability for the end use of the details. For conditions not shown, consult Sika for review of specific details.

- Install Sika materials in accordance with current installation instructions.
- Unsatisfactory conditions shall be reported to the General Contractor and corrected before the application of Sika products.

Senturion I System

TYPICAL CLAD WINDOW JAMB W/ BAND

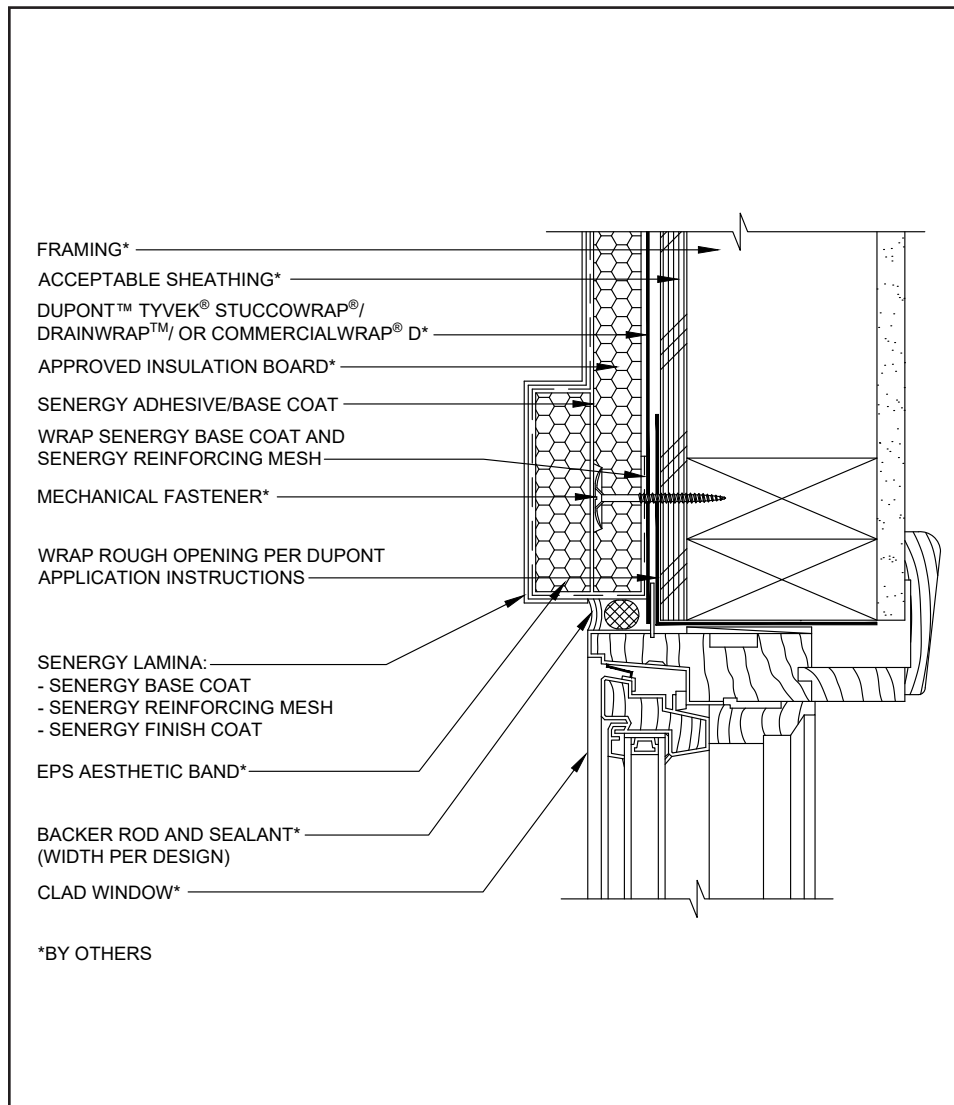

- All terminations must be fully encapsulated with mesh reinforced base coat. Extend reinforcing mesh a minimum of 2 1/2" onto back of insulation board.
- Prior to window and EPS installation, ensure water-resistive barrier is properly applied into the rough openings in accordance with the manufacturer's application guidelines and code requirements.
- Do not apply finish to areas that will receive sealant.
- Provide a back wrapped type joint with backer rod and sealant at system terminations to dissimilar materials, ensuring that a water tight seal is achieved (width per design).
- Reference *Acceptable Sealants for use with Senergy Wall Systems* Technical Bulletin for a list of sealants.
- Consult window and sealant manufacturers to verify window installation, detailing and to ensure no water leakage into the wall assembly.

05 0524

(*NOTE: BY OTHERS)

The details within are the latest recommendations and are represented in good faith by Sika Corporation US (hereinafter Sika). The details are subject to change without notice. Sika accepts no liability for the end use of the details. For conditions not shown, consult Sika for review of specific details.

- Install Sika materials in accordance with current installation instructions.
- Unsatisfactory conditions shall be reported to the General Contractor and corrected before the application of Sika products.

Senturion I System

TYPICAL CLAD WINDOW HEAD W/ BAND

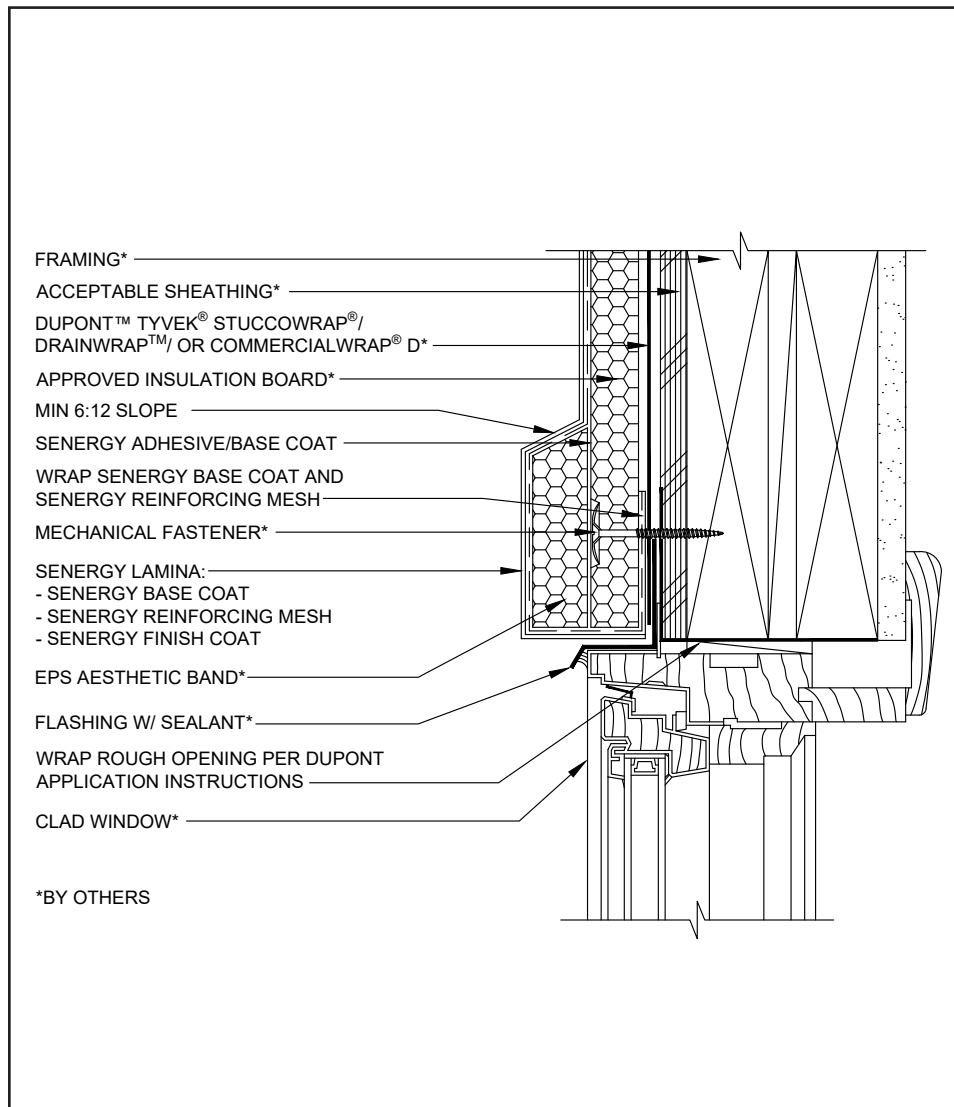

06 0524

(*NOTE: BY OTHERS)

- All terminations must be fully encapsulated with mesh reinforced base coat. Pre-backwrapping is recommended at drainage terminations. Extend reinforcing mesh a minimum of 2 ½" onto back of insulation board.
- On horizontal projections greater than 1" (25mm) maintain a minimum 6:12 slope. For sloped surfaces over 24" (340mm), a roofing system or a metal cap flashing is required.
- Ensure a means for drainage is provided at system termination at window head.
- Provide end-dams at flashing terminations.
- Prior to window and EPS installation, ensure water-resistive barrier is properly applied into the rough openings in accordance with the manufacturer's application guidelines and code requirements.
- Consult window and sealant manufacturers to verify window installation, detailing and to ensure no water leakage into the wall assembly.

The details within are the latest recommendations and are represented in good faith by Sika Corporation US (hereinafter Sika). The details are subject to change without notice. Sika accepts no liability for the end use of the details. For conditions not shown, consult Sika for review of specific details.

- Install Sika materials in accordance with current installation instructions.
- Unsatisfactory conditions shall be reported to the General Contractor and corrected before the application of Sika products.

Senturion I System

TYPICAL CLAD WINDOW SILL W/ BAND

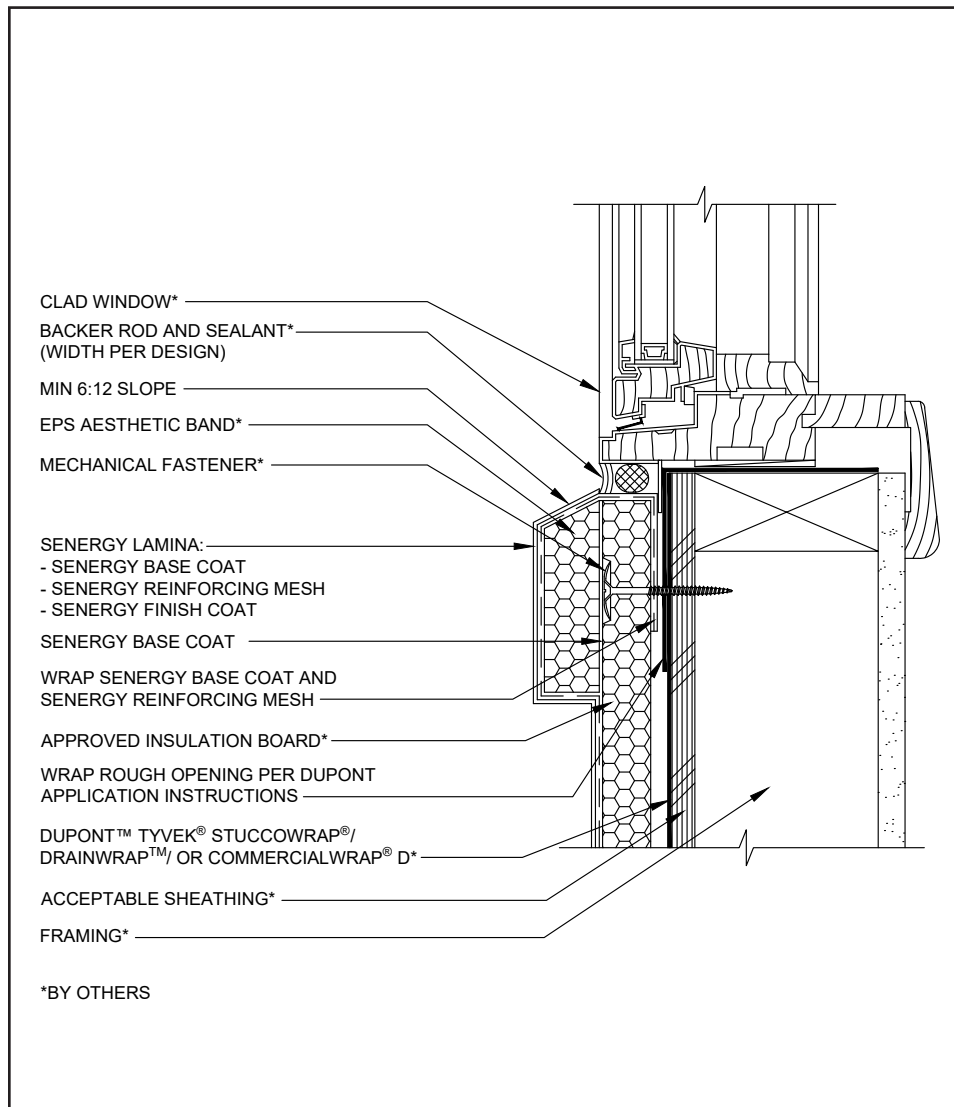

- Maintain a minimum 6:12 slope.
- All terminations must be fully encapsulated with mesh reinforced base coat. Extend reinforcing mesh a minimum of 2 ½" onto back of insulation board.
- Prior to window and EPS installation, ensure water-resistive barrier is properly applied into the rough openings in accordance with the manufacturer's application guidelines and code requirements.
- Do not apply finish to areas that will receive sealant.
- Provide a back wrapped type joint with backer rod and sealant at system terminations to dissimilar materials, ensuring that a water tight seal is achieved (width per design).

07 0524

(*NOTE: BY OTHERS)

The details within are the latest recommendations and are represented in good faith by Sika Corporation US (hereinafter Sika). The details are subject to change without notice. Sika accepts no liability for the end use of the details. For conditions not shown, consult Sika for review of specific details.

- Install Sika materials in accordance with current installation instructions.
- Unsatisfactory conditions shall be reported to the General Contractor and corrected before the application of Sika products.

Senturion I System

TYPICAL CLAD WINDOW JAMB

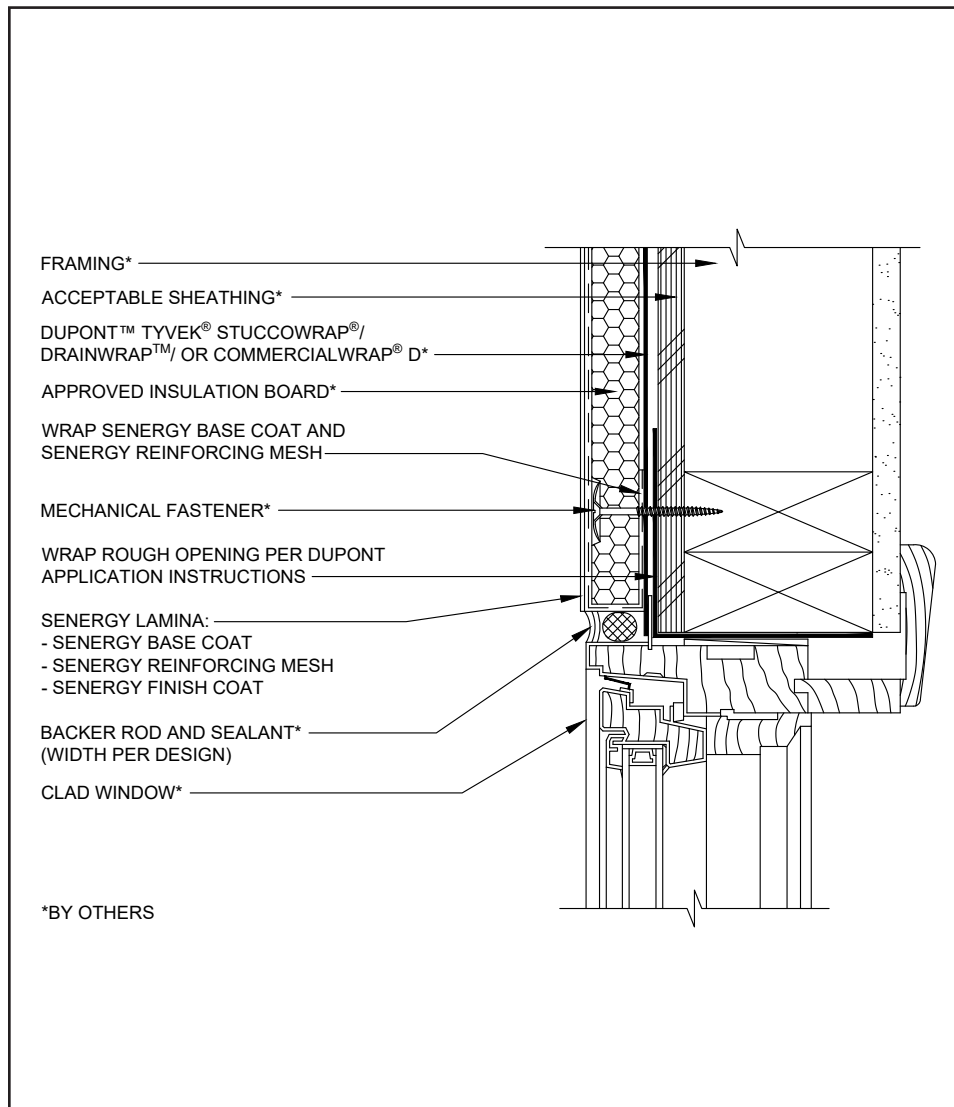

- All terminations must be fully encapsulated with mesh reinforced base coat. Extend reinforcing mesh a minimum of 2 ½" onto back of insulation board.
- Prior to window and EPS installation, ensure water-resistive barrier is properly applied into the rough openings in accordance with the manufacturer's application guidelines and code requirements.
- Do not apply finish to areas that will receive sealant.
- Provide a back wrapped type joint with backer rod and sealant at system terminations to dissimilar materials, ensuring that a water tight seal is achieved (width per design).
- Reference *Acceptable Sealants for use with Senergy Wall Systems* Technical Bulletin for a list of sealants.
- Consult window and sealant manufacturers to verify window installation, detailing and to ensure no water leakage into the wall assembly.

08 0524

(*NOTE: BY OTHERS)

The details within are the latest recommendations and are represented in good faith by Sika Corporation US (hereinafter Sika). The details are subject to change without notice. Sika accepts no liability for the end use of the details. For conditions not shown, consult Sika for review of specific details.

- Install Sika materials in accordance with current installation instructions.
- Unsatisfactory conditions shall be reported to the General Contractor and corrected before the application of Sika products.

Senturion I System

TYPICAL CLAD WINDOW HEAD

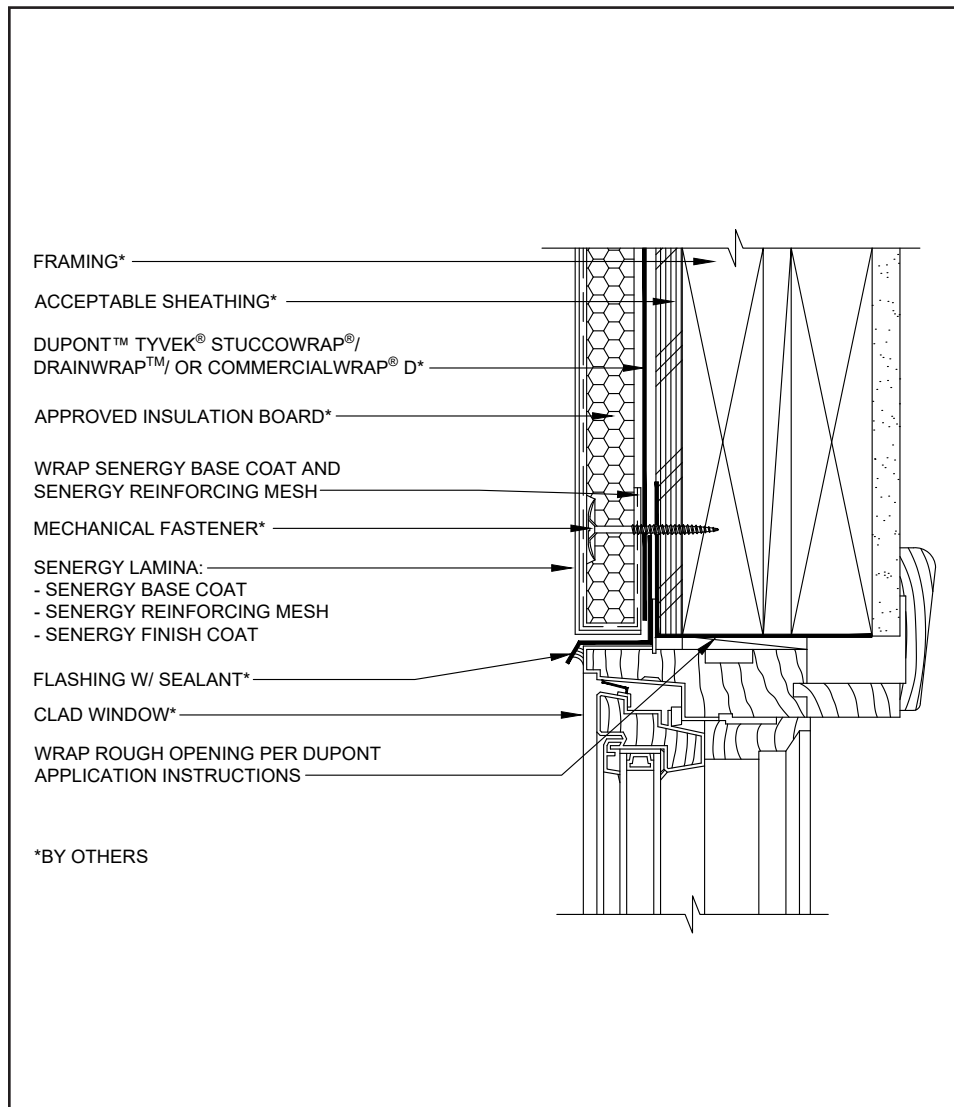

- All terminations must be fully encapsulated with mesh reinforced base coat. Pre-backwrapping is recommended at drainage terminations. Extend reinforcing mesh a minimum of 2 ½" onto back of insulation board.
- Ensure a means for drainage is provided at system termination at window head.
- Provide end-dams at flashing terminations.
- Prior to window and EPS installation, ensure water-resistive barrier is properly applied into the rough openings in accordance with the manufacturer's application guidelines and code requirements.
- Consult window and sealant manufacturers to verify window installation, detailing and to ensure no water leakage into the wall assembly.

09 0524

(*NOTE: BY OTHERS)

The details within are the latest recommendations and are represented in good faith by Sika Corporation US (hereinafter Sika). The details are subject to change without notice. Sika accepts no liability for the end use of the details. For conditions not shown, consult Sika for review of specific details.

- Install Sika materials in accordance with current installation instructions.
- Unsatisfactory conditions shall be reported to the General Contractor and corrected before the application of Sika products.

Senturion I System

TYPICAL CLAD WINDOW SILL

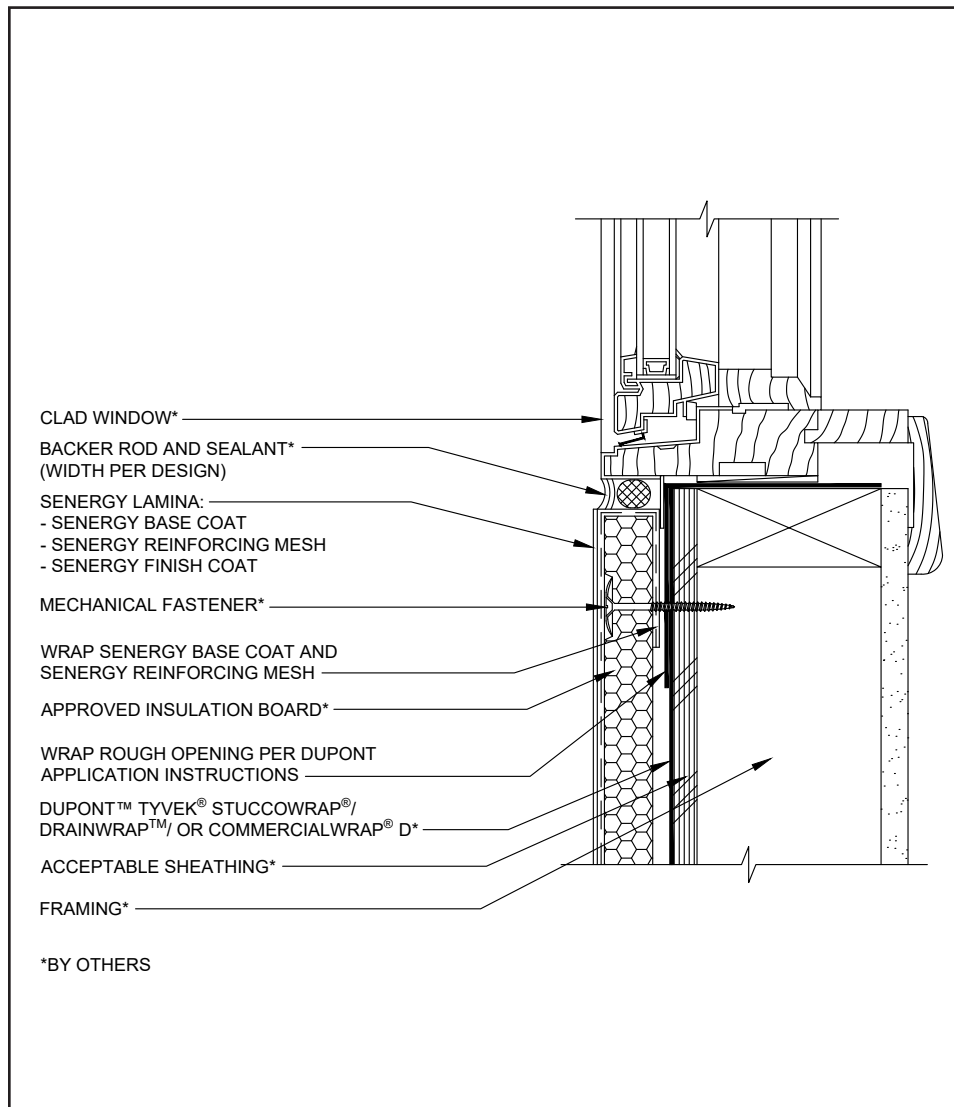

- All terminations must be fully encapsulated with mesh reinforced base coat. Extend reinforcing mesh a minimum of 2 1/2" onto back of insulation board.
- Prior to window and EPS installation, ensure water-resistive barrier is properly applied into the rough openings in accordance with the manufacturer's application guidelines and code requirements.
- Do not apply finish to areas that will receive sealant.
- Provide a back wrapped type joint with backer rod and sealant at system terminations to dissimilar materials, ensuring that a water tight seal is achieved (width per design).
- Reference *Acceptable Sealants for use with Senergy Wall Systems* Technical Bulletin for a list of sealants.
- Consult window and sealant manufacturers to verify window installation, detailing and to ensure no water leakage into the wall assembly.

10 0524

(*NOTE: BY OTHERS)

The details within are the latest recommendations and are represented in good faith by Sika Corporation US (hereinafter Sika). The details are subject to change without notice. Sika accepts no liability for the end use of the details. For conditions not shown, consult Sika for review of specific details.

- Install Sika materials in accordance with current installation instructions.
- Unsatisfactory conditions shall be reported to the General Contractor and corrected before the application of Sika products.

Senturion I System

TYPICAL PRIMED WINDOW JAMB

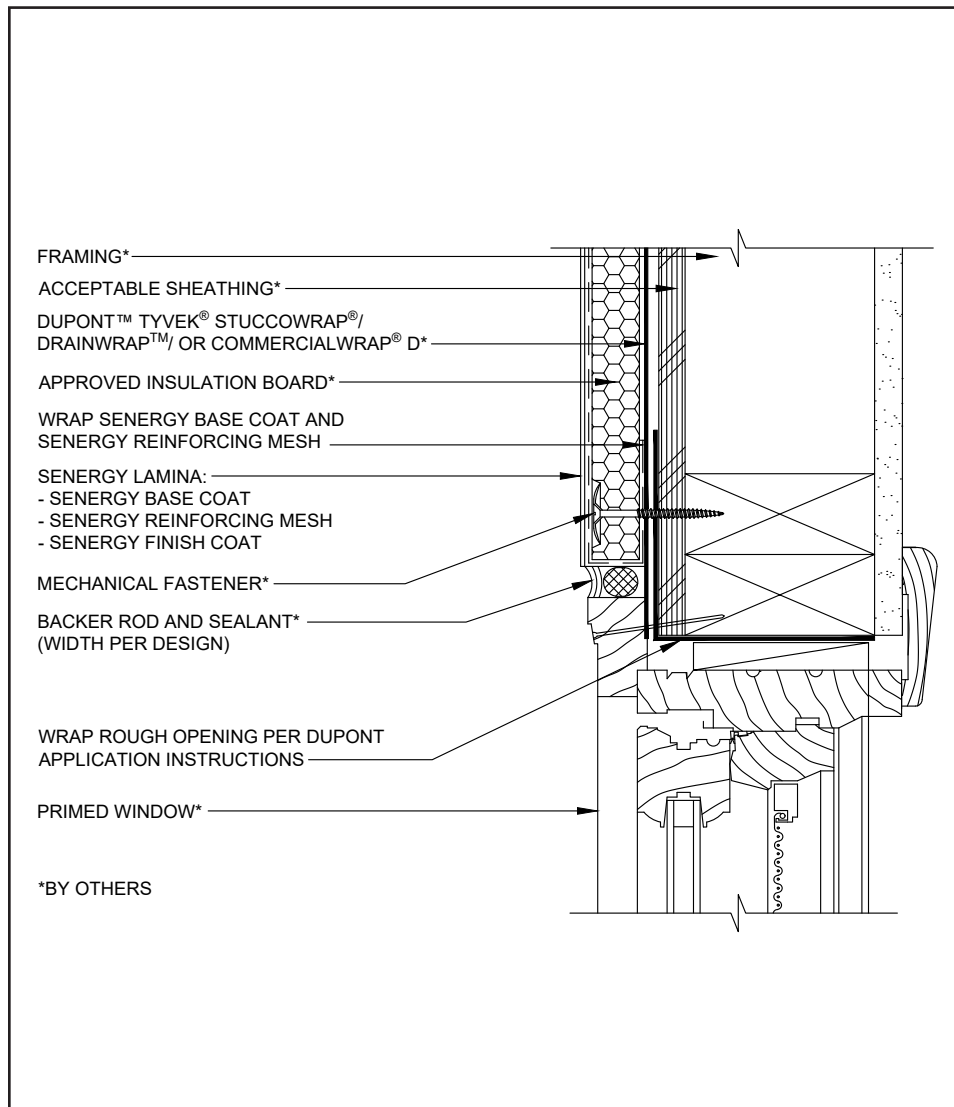

- All terminations must be fully encapsulated with mesh reinforced base coat. Extend reinforcing mesh a minimum of 2 ½" onto back of insulation board.
- Prior to window and EPS installation, ensure water-resistive barrier is properly applied into the rough openings in accordance with the manufacturer's application guidelines and code requirements.
- Do not apply finish to areas that will receive sealant.
- Provide a back wrapped type joint with backer rod and sealant at system terminations to dissimilar materials, ensuring that a water tight seal is achieved (width per design).
- Reference *Acceptable Sealants for use with Senergy Wall Systems* Technical Bulletin for a list of sealants.
- Consult window and sealant manufacturers to verify window installation, detailing and to ensure no water leakage into the wall assembly.

11 0524

(*NOTE: BY OTHERS)

The details within are the latest recommendations and are represented in good faith by Sika Corporation US (hereinafter Sika). The details are subject to change without notice. Sika accepts no liability for the end use of the details. For conditions not shown, consult Sika for review of specific details.

- Install Sika materials in accordance with current installation instructions.
- Unsatisfactory conditions shall be reported to the General Contractor and corrected before the application of Sika products.

Senturion I System

TYPICAL PRIMED WINDOW HEAD

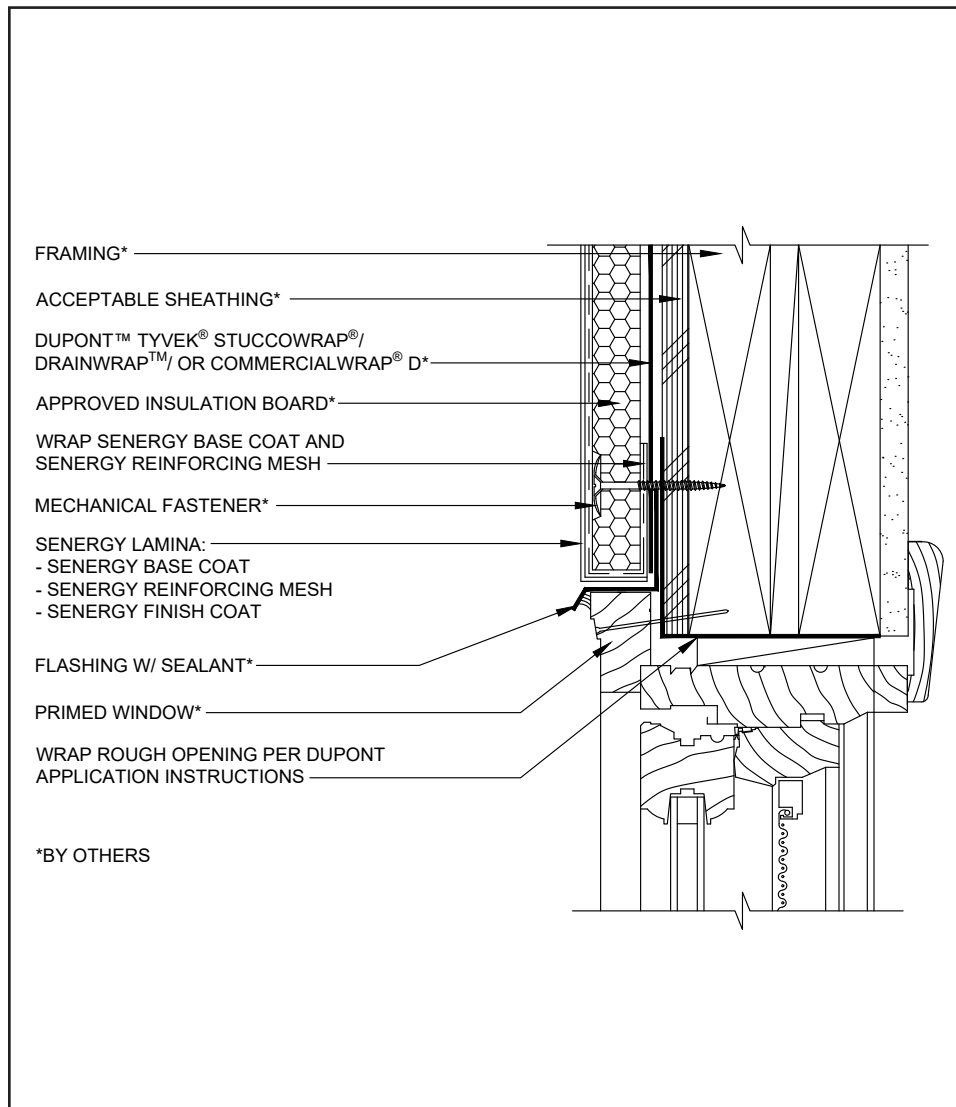

- All terminations must be fully encapsulated with mesh reinforced base coat. Pre-backwrapping is recommended at drainage terminations. Extend reinforcing mesh a minimum of 2 ½" onto back of insulation board.
- Ensure a means for drainage is provided at system termination at window head.
- Provide end-dams at flashing terminations.
- Prior to window and EPS installation, ensure water-resistive barrier is properly applied into the rough openings in accordance with the manufacturer's application guidelines and code requirements.
- Consult window and sealant manufacturers to verify window installation, detailing and to ensure no water leakage into the wall assembly.

12 0524

(*NOTE: BY OTHERS)

The details within are the latest recommendations and are represented in good faith by Sika Corporation US (hereinafter Sika). The details are subject to change without notice. Sika accepts no liability for the end use of the details. For conditions not shown, consult Sika for review of specific details.

- Install Sika materials in accordance with current installation instructions.
- Unsatisfactory conditions shall be reported to the General Contractor and corrected before the application of Sika products.

Senturion I System

TYPICAL PRIMED WINDOW SILL

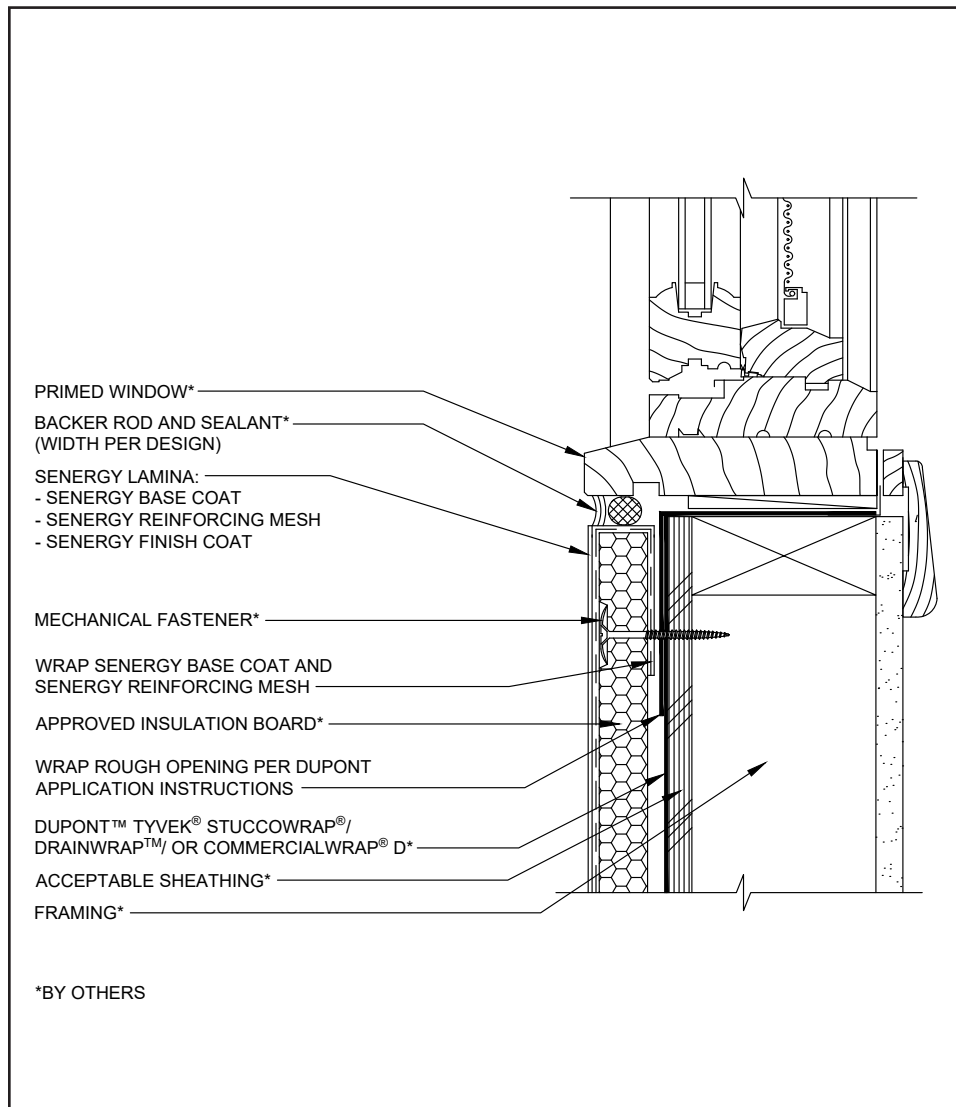

- All terminations must be fully encapsulated with mesh reinforced base coat. Extend reinforcing mesh a minimum of 2 ½" onto back of insulation board.
- Prior to window and EPS installation, ensure water-resistive barrier is properly applied into the rough openings in accordance with the manufacturer's application guidelines and code requirements.
- Do not apply finish to areas that will receive sealant.
- Provide a back wrapped type joint with backer rod and sealant at system terminations to dissimilar materials, ensuring that a water tight seal is achieved (width per design).
- Reference *Acceptable Sealants for use with Senergy Wall Systems* Technical Bulletin for a list of sealants.
- Consult window and sealant manufacturers to verify window installation, detailing and to ensure no water leakage into the wall assembly.

13 0524

(*NOTE: BY OTHERS)

The details within are the latest recommendations and are represented in good faith by Sika Corporation US (hereinafter Sika). The details are subject to change without notice. Sika accepts no liability for the end use of the details. For conditions not shown, consult Sika for review of specific details.

- Install Sika materials in accordance with current installation instructions.
- Unsatisfactory conditions shall be reported to the General Contractor and corrected before the application of Sika products.

Senturion I System

TYPICAL EXPANSION JOINT AT FLOOR LINE

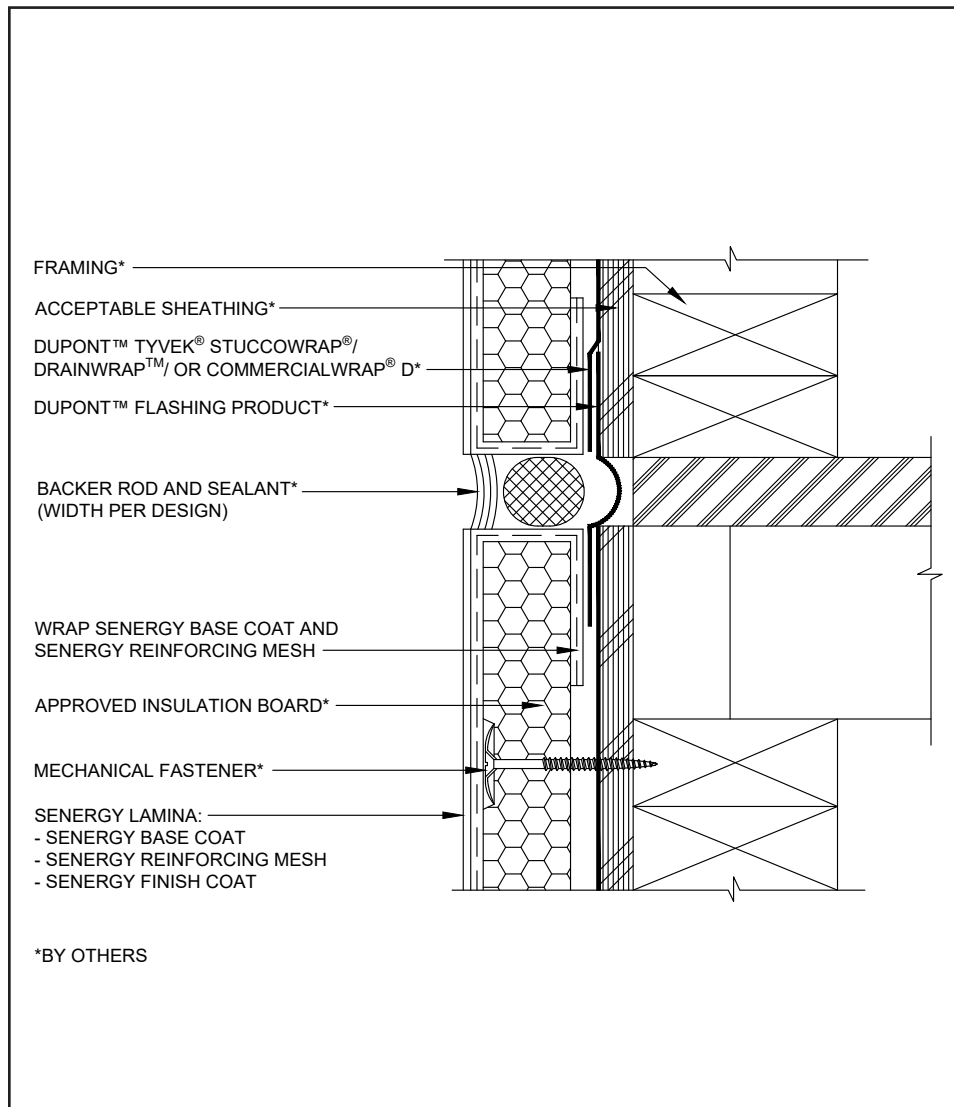

- All terminations must be fully encapsulated with mesh reinforced base coat. Pre-backwrapping is recommended at drainage terminations. Extend reinforcing mesh a minimum of 2 ½" onto back of insulation board.
- Do not apply finish to areas that will receive sealant.
- Provide sufficient slack in the SikaWall Flash Seal NP or flashing membrane at expansion joint to allow for movement.
- Typical locations for system expansion joints are at building expansion joints, at prefabricated panel joints, floor lines of wood frame construction or where slip tracks are used in steel frame construction, where substrates change and where structural movement is anticipated. It is the sole responsibility of the project design team, including the architect, engineer, etc., to ultimately determine specific expansion joint placement, width and design. Detail specific locations in construction drawings.
- It is recommended that a means for drainage is provided at every third floor.
- Ensure drainage plane is continuous and unobstructed at expansion joint.
- Reference *Acceptable Sealants for use with Senergy Wall Systems* Technical Bulletin for a list of sealants.

14 0524

(*NOTE: BY OTHERS)

The details within are the latest recommendations and are represented in good faith by Sika Corporation US (hereinafter Sika). The details are subject to change without notice. Sika accepts no liability for the end use of the details. For conditions not shown, consult Sika for review of specific details.

- Install Sika materials in accordance with current installation instructions.
- Unsatisfactory conditions shall be reported to the General Contractor and corrected before the application of Sika products.

Senturion I System

TYPICAL EXPANSION JOINT AT CHANGE IN SUBSTRATE

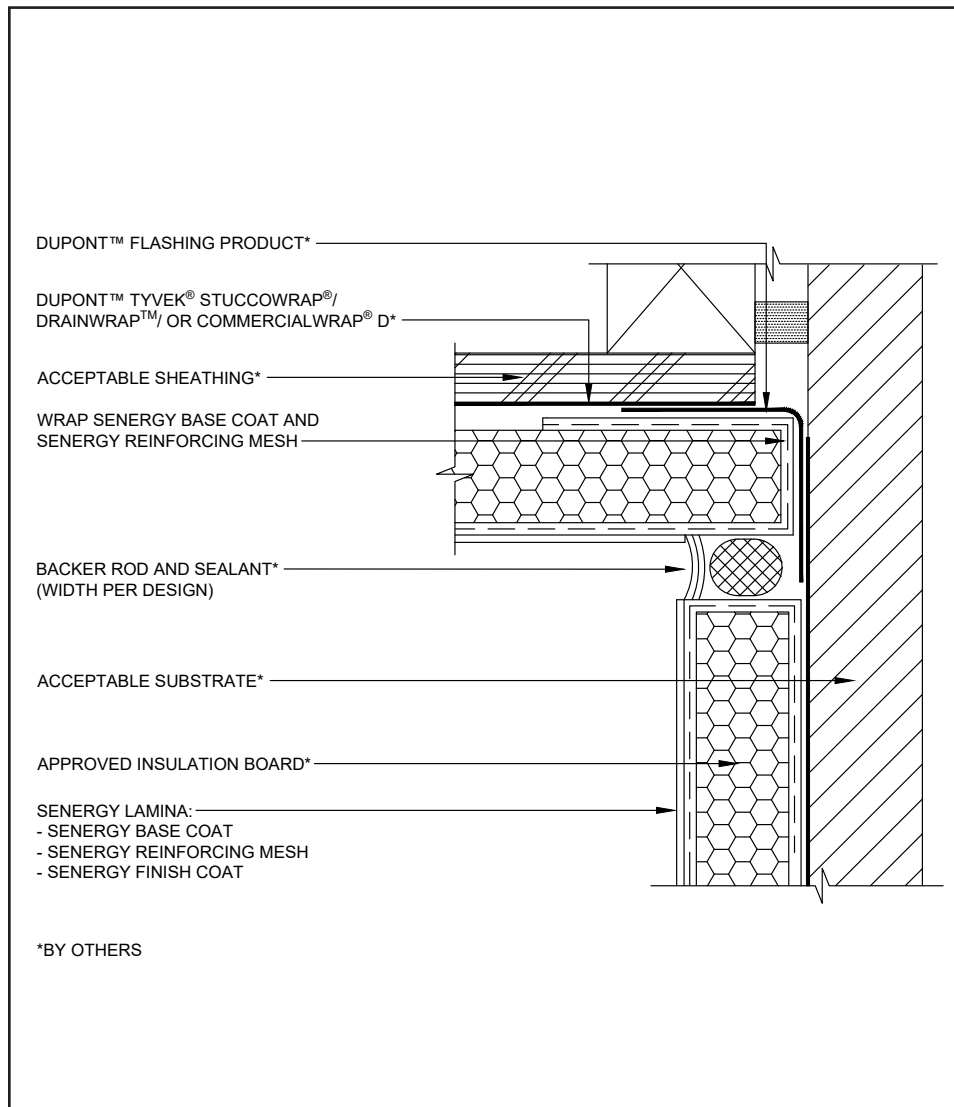

- All terminations must be fully encapsulated with mesh reinforced base coat. Extend reinforcing mesh a minimum of 2 ½" onto back of insulation board.
- Do not apply finish to areas that will receive sealant.
- Ensure drainage plane is continuous and unobstructed at expansion joint.
- Typical locations for system expansion joints are at building expansion joints, at prefabricated panel joints, floor lines of wood frame construction or where slip tracks are used in steel frame construction, where substrates change and where structural movement is anticipated. It is the sole responsibility of the project design team, including the architect, engineer, etc., to ultimately determine specific expansion joint placement, width and design. Detail specific locations in construction drawings.
- Provide sufficient slack in SikaWall Flash Seal NP or flashing membrane at expansion joint to allow for movement.
- Reference *Acceptable Sealants for use with Senergy Wall Systems* Technical Bulletin for a list of sealants.

15 0524

(*NOTE: BY OTHERS)

The details within are the latest recommendations and are represented in good faith by Sika Corporation US (hereinafter Sika). The details are subject to change without notice. Sika accepts no liability for the end use of the details. For conditions not shown, consult Sika for review of specific details.

- Install Sika materials in accordance with current installation instructions.
- Unsatisfactory conditions shall be reported to the General Contractor and corrected before the application of Sika products.

Senturion I System

TYPICAL TERMINATION AT SOFFIT OR GABLE

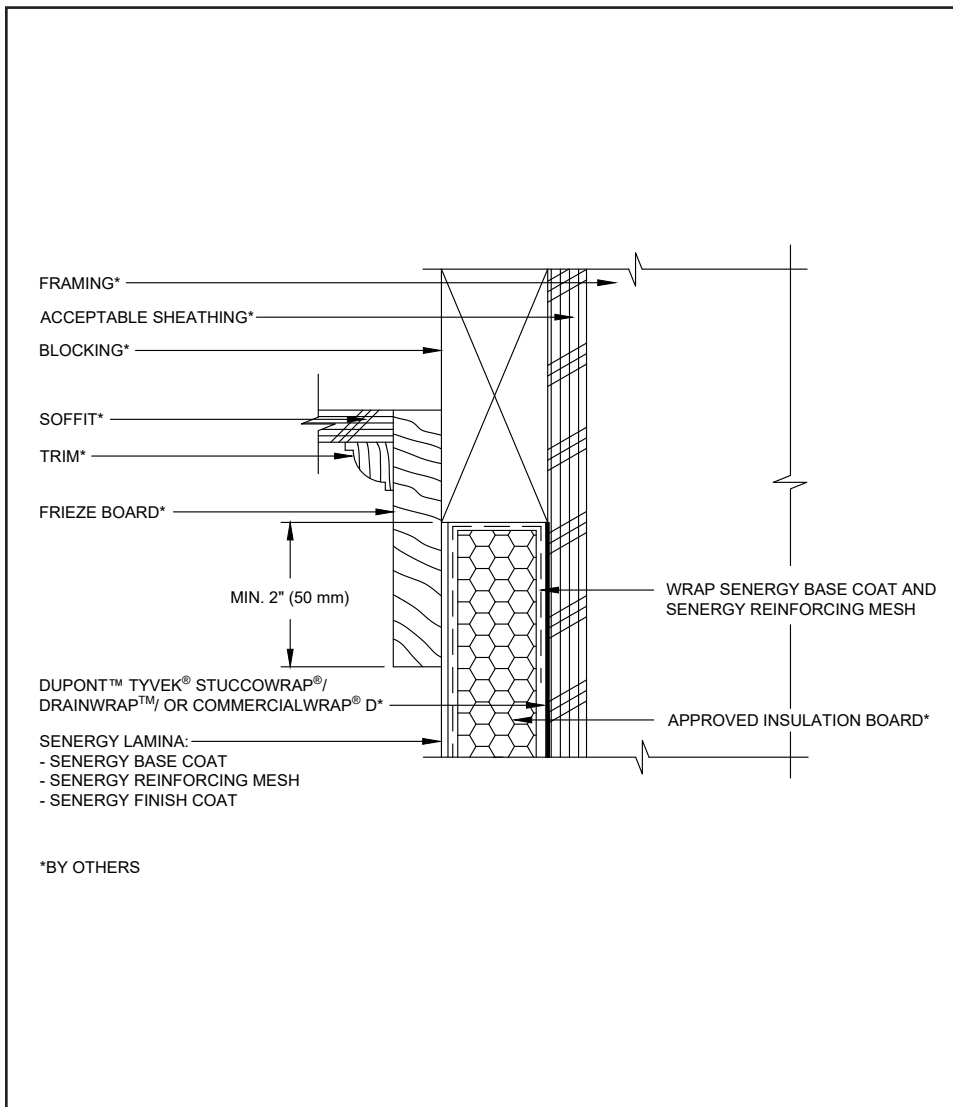

- All terminations must be fully encapsulated with mesh reinforced base coat. Extend reinforcing mesh a minimum of 2 ½" onto back of insulation board.

16 0524

(*NOTE: BY OTHERS)

The details within are the latest recommendations and are represented in good faith by Sika Corporation US (hereinafter Sika). The details are subject to change without notice. Sika accepts no liability for the end use of the details. For conditions not shown, consult Sika for review of specific details.

- Install Sika materials in accordance with current installation instructions.
- Unsatisfactory conditions shall be reported to the General Contractor and corrected before the application of Sika products.

Senturion I System

TYPICAL DOWNSPOUT

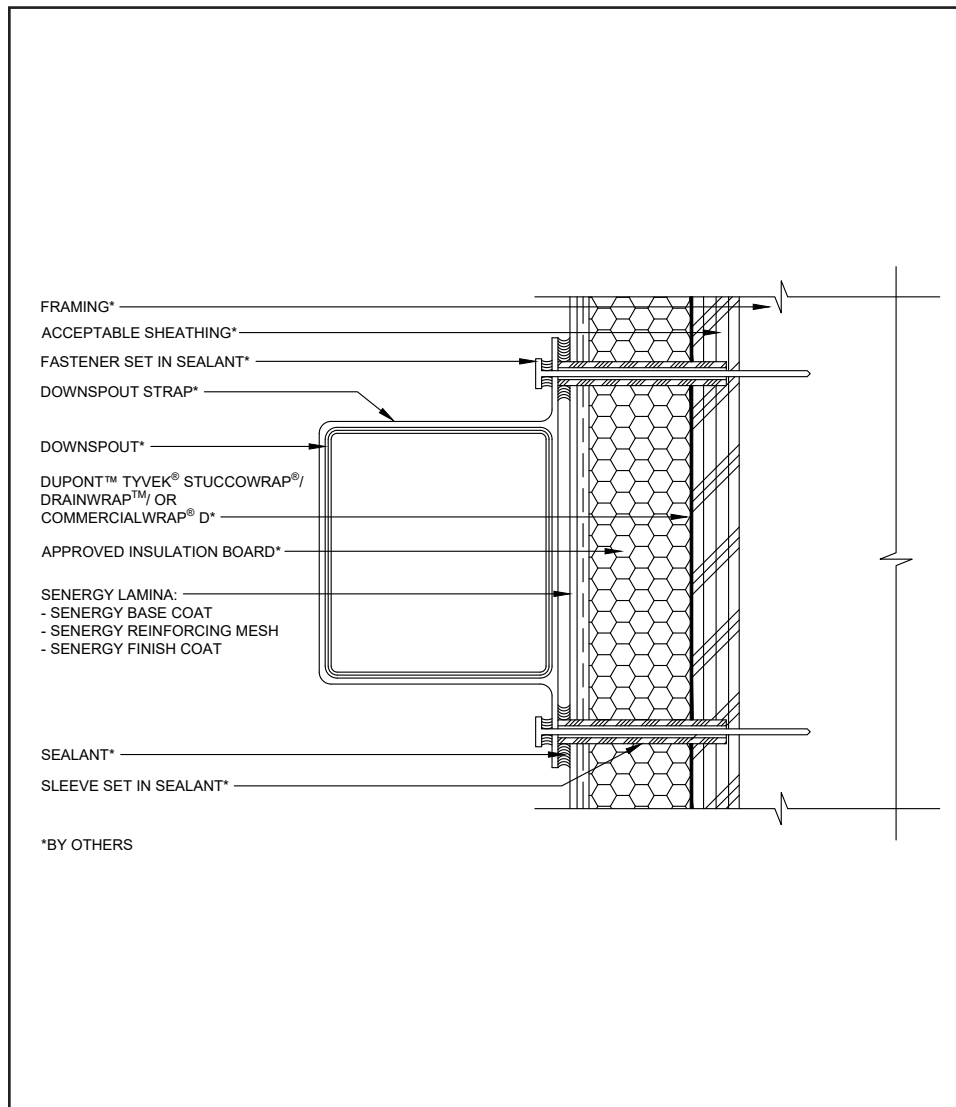

- Ensure all penetrations into the system are properly sealed.
- Reference *Acceptable Sealants for use with Senergy Wall Systems* Technical Bulletin for a list of sealants.

17 0524

(*NOTE: BY OTHERS)

The details within are the latest recommendations and are represented in good faith by Sika Corporation US (hereinafter Sika). The details are subject to change without notice. Sika accepts no liability for the end use of the details. For conditions not shown, consult Sika for review of specific details.

- Install Sika materials in accordance with current installation instructions.
- Unsatisfactory conditions shall be reported to the General Contractor and corrected before the application of Sika products.

Senturion I System

TYPICAL PIPE PENETRATION

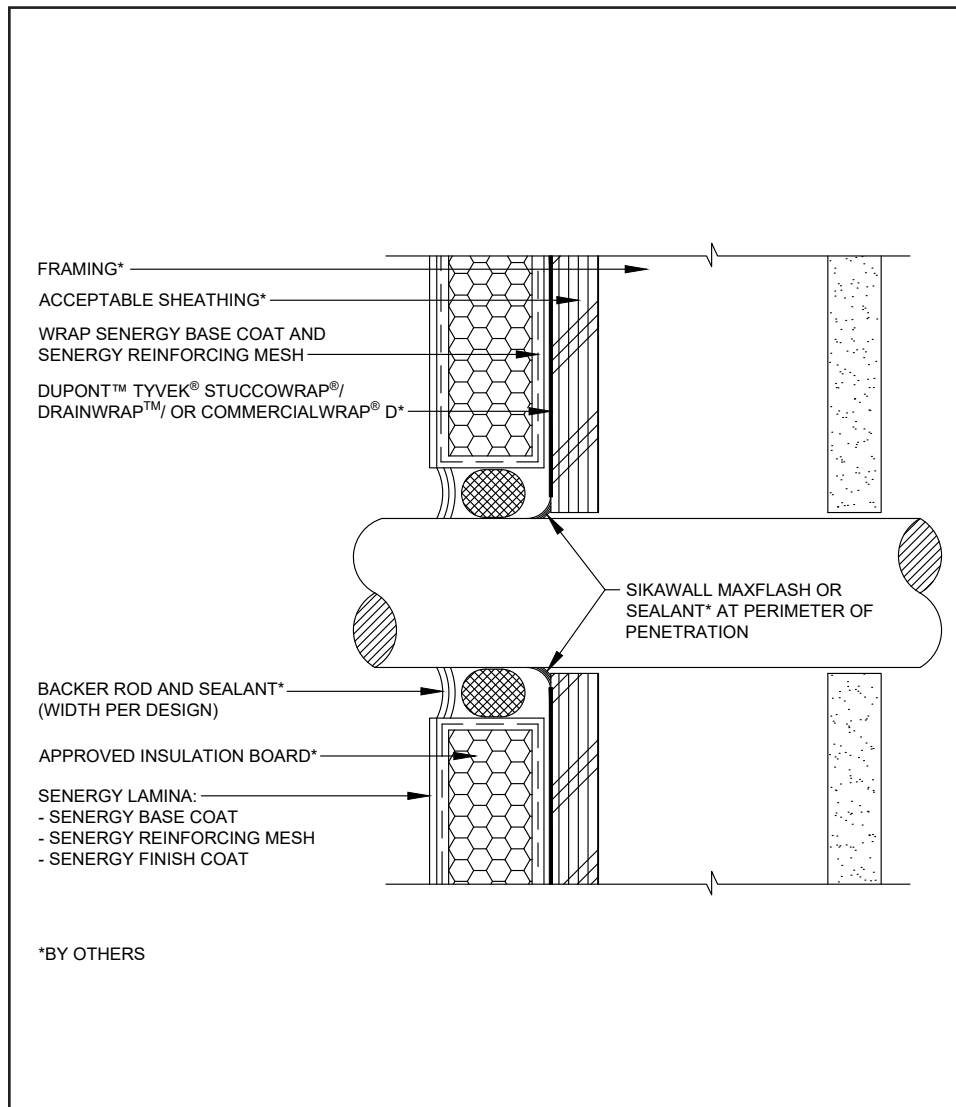

- All terminations must be fully encapsulated with mesh reinforced basecoat. Extend reinforcing mesh a minimum of 2 ½" onto back of insulation board.
- Ensure all penetrations into the system are properly sealed. Reference Acceptable Sealants to use with Senergy Wall Systems Technical Bulletin for a list of sealants.
- Provide continuous air seal around perimeter of penetration prior to EPS insulation board application.
- Do not apply finish to areas that will receive sealant.

18 0524

(*NOTE: BY OTHERS)

The details within are the latest recommendations and are represented in good faith by Sika Corporation US (hereinafter Sika). The details are subject to change without notice. Sika accepts no liability for the end use of the details. For conditions not shown, consult Sika for review of specific details.

- Install Sika materials in accordance with current installation instructions.
- Unsatisfactory conditions shall be reported to the General Contractor and corrected before the application of Sika products.

Senturion I System

TYPICAL LIGHT FIXTURE

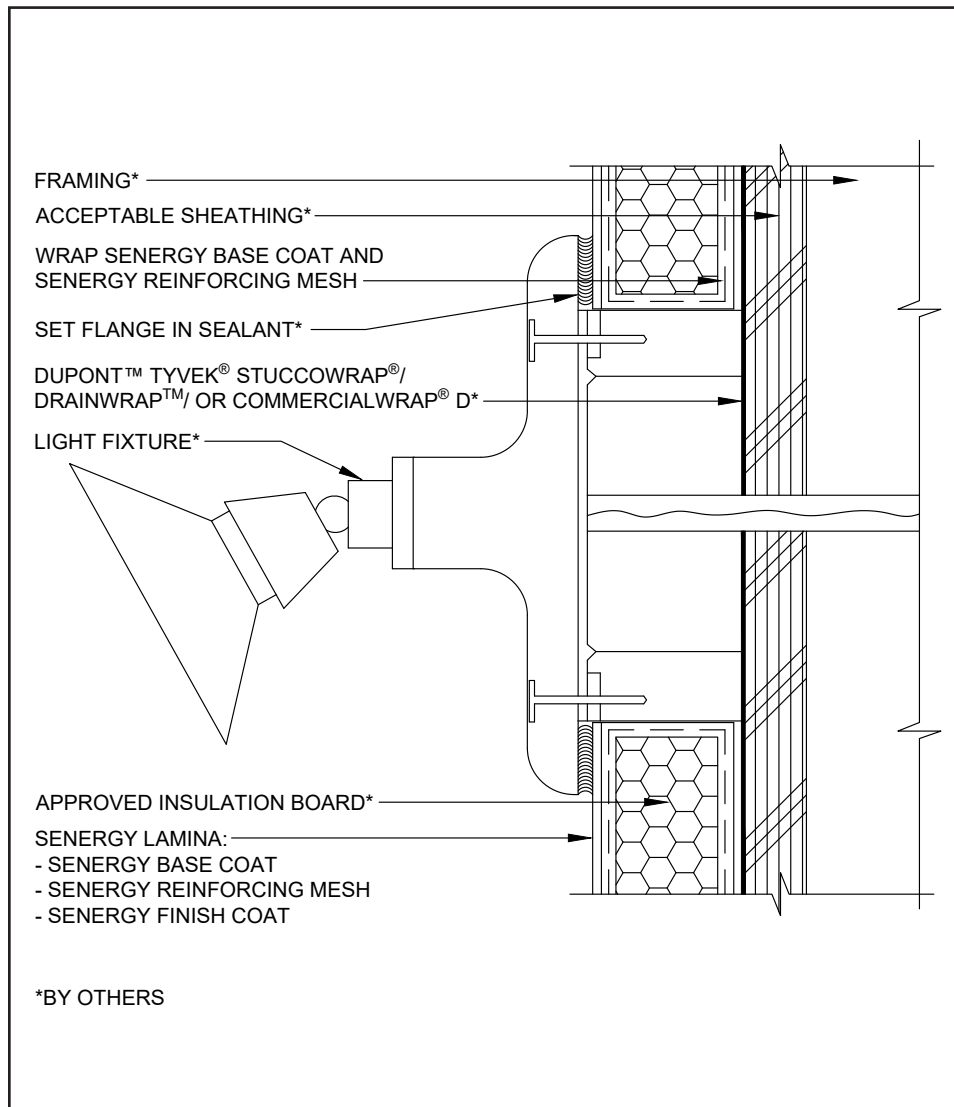

- All terminations must be fully encapsulated with mesh reinforced base coat. Pre-backwrap both the vertical and horizontal terminations. Extend reinforcing mesh a minimum of 2 ½" onto back of insulation board.
- Ensure all penetrations into the system are properly sealed.
- Reference *Acceptable Sealants to use with Senergy Wall Systems* Technical Bulletin for a list of sealants.
- Provide continuous air seal around perimeter of penetration prior to EPS insulation board application.

19 0524

(*NOTE: BY OTHERS)

The details within are the latest recommendations and are represented in good faith by Sika Corporation US (hereinafter Sika). The details are subject to change without notice. Sika accepts no liability for the end use of the details. For conditions not shown, consult Sika for review of specific details.

- Install Sika materials in accordance with current installation instructions.
- Unsatisfactory conditions shall be reported to the General Contractor and corrected before the application of Sika products.

Senturion I System

TYPICAL DRYER VENT

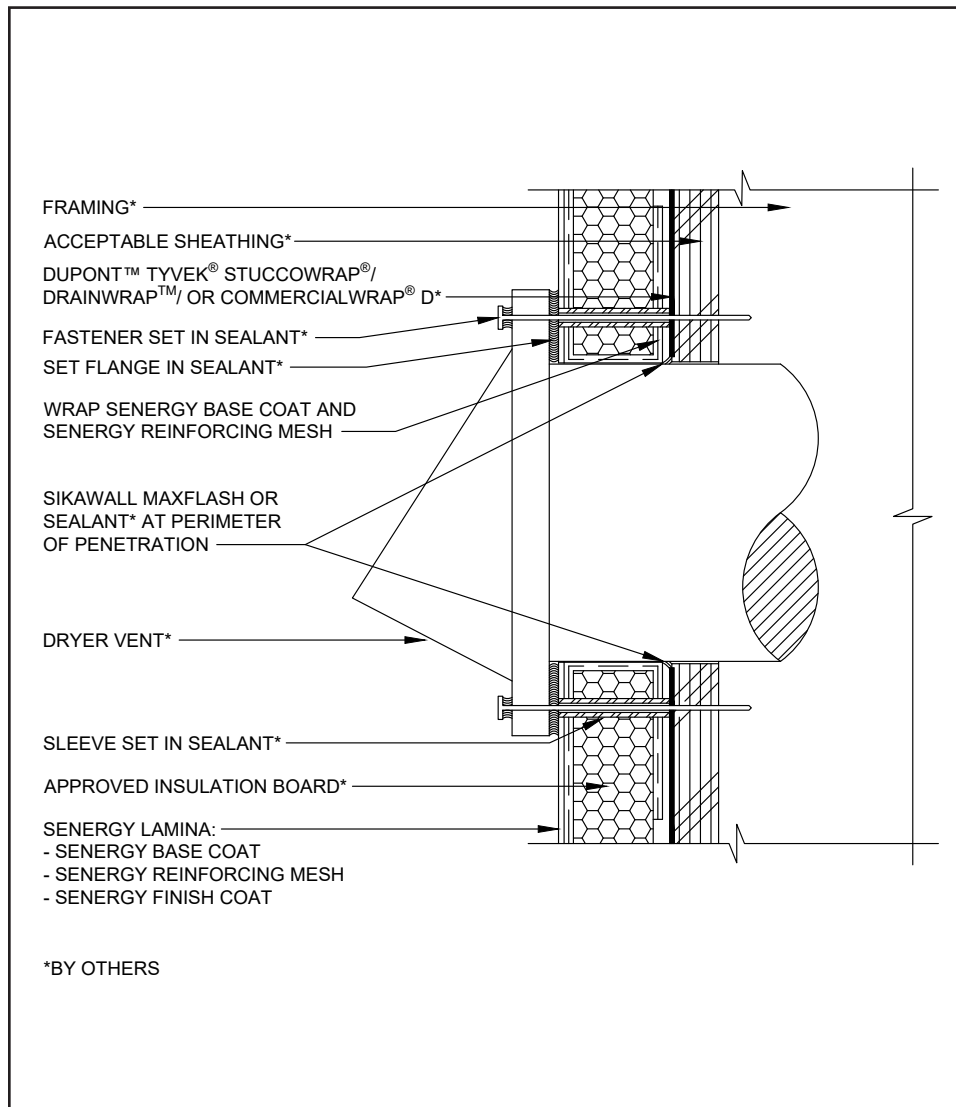

- All terminations must be fully encapsulated with mesh reinforced basecoat. Extend reinforcing mesh a minimum of 2 1/2" onto back of insulation board.
- Ensure all penetrations into the system are properly sealed. Reference *Acceptable Sealants to use with Senergy Wall Systems* Technical Bulletin for a list of sealants.
- Provide continuous air seal around perimeter of penetration prior to EPS insulation board application.
- Do not apply finish to areas that will receive sealant.
- Ensure all penetrations into the system are properly sealed.

20 0524

(*NOTE: BY OTHERS)

The details within are the latest recommendations and are represented in good faith by Sika Corporation US (hereinafter Sika). The details are subject to change without notice. Sika accepts no liability for the end use of the details. For conditions not shown, consult Sika for review of specific details.

- Install Sika materials in accordance with current installation instructions.
- Unsatisfactory conditions shall be reported to the General Contractor and corrected before the application of Sika products.

Senturion I System

TYPICAL TERMINATION AT TOP OF DECK

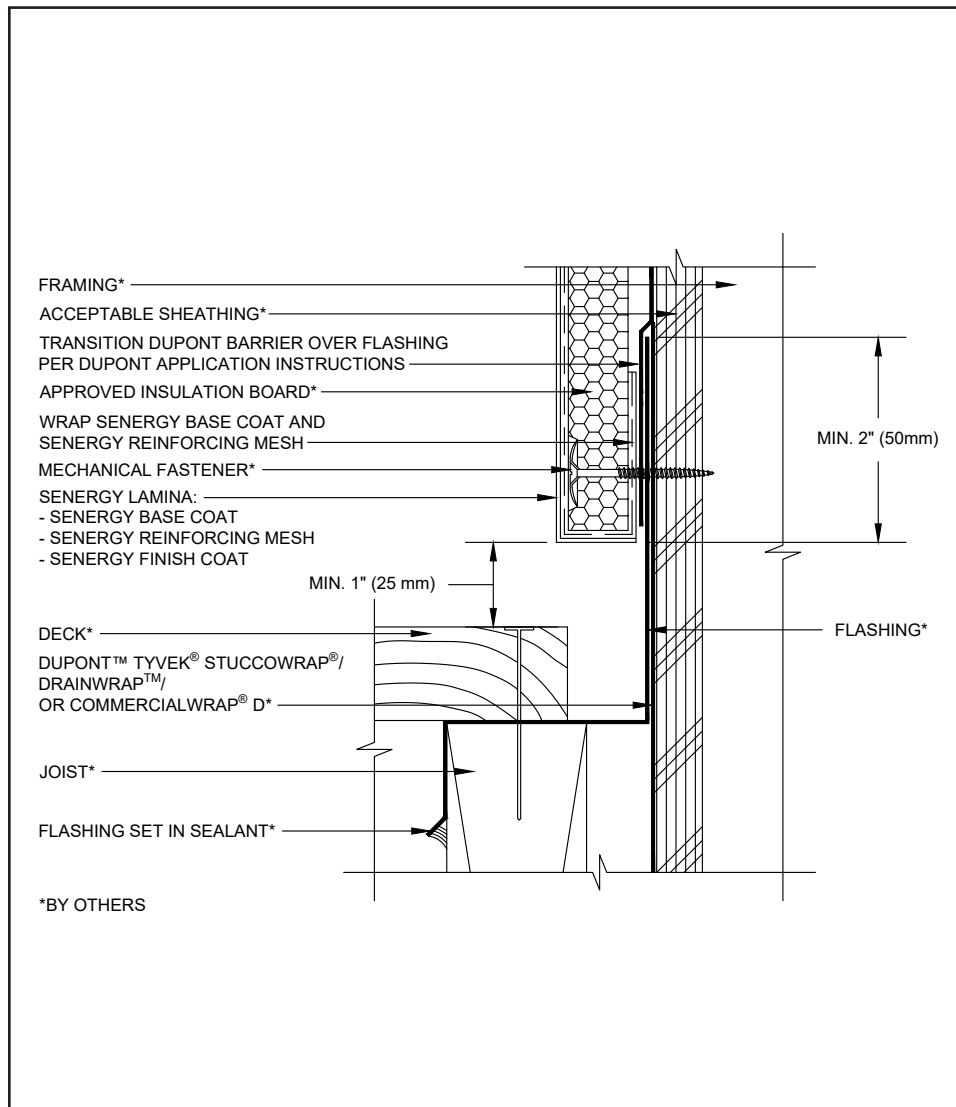

- All terminations must be fully encapsulated with mesh reinforced base coat. Pre-backwrapping is recommended at drainage terminations. Extend reinforcing mesh a minimum of 2 ½" onto back of insulation board.
- Ensure a means for drainage is provided at system termination at deck.
- Terminate system a minimum of 1" (25 mm) above deck.

21 0524

(*NOTE: BY OTHERS)

The details within are the latest recommendations and are represented in good faith by Sika Corporation US (hereinafter Sika). The details are subject to change without notice. Sika accepts no liability for the end use of the details. For conditions not shown, consult Sika for review of specific details.

- Install Sika materials in accordance with current installation instructions.
- Unsatisfactory conditions shall be reported to the General Contractor and corrected before the application of Sika products.

Senturion I System

TYPICAL TERMINATION AT BOTTOM OF DECK

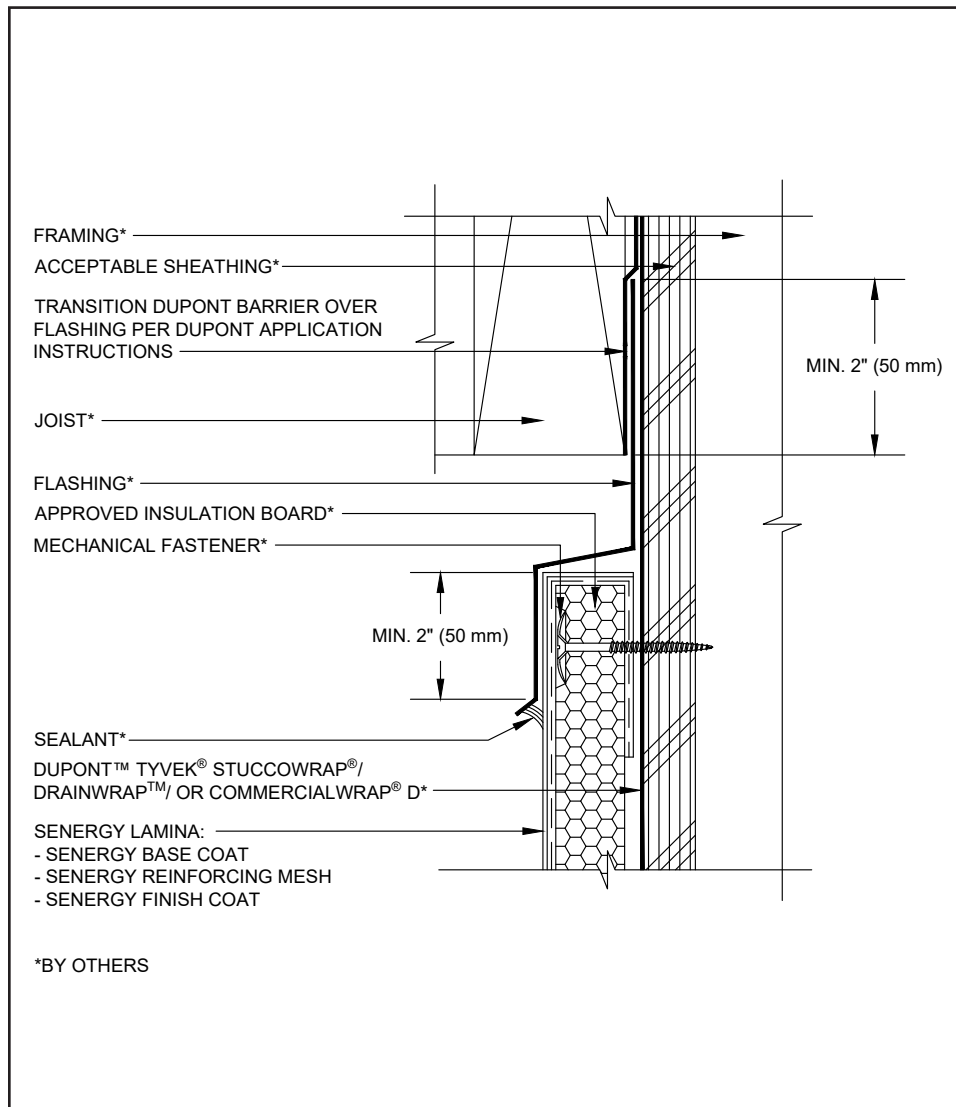

- All terminations must be fully encapsulated with mesh reinforced base coat. Extend reinforcing mesh a minimum of 2 ½" onto back of insulation board.
- Ensure that metal coping/ flashing extends onto the system a minimum of 2" (50 mm) down the face.

22 0524

(*NOTE: BY OTHERS)

The details within are the latest recommendations and are represented in good faith by Sika Corporation US (hereinafter Sika). The details are subject to change without notice. Sika accepts no liability for the end use of the details. For conditions not shown, consult Sika for review of specific details.

- Install Sika materials in accordance with current installation instructions.
- Unsatisfactory conditions shall be reported to the General Contractor and corrected before the application of Sika products.

Senturion I System

TYPICAL TERMINATION AT FOUNDATION W/ FLASHING

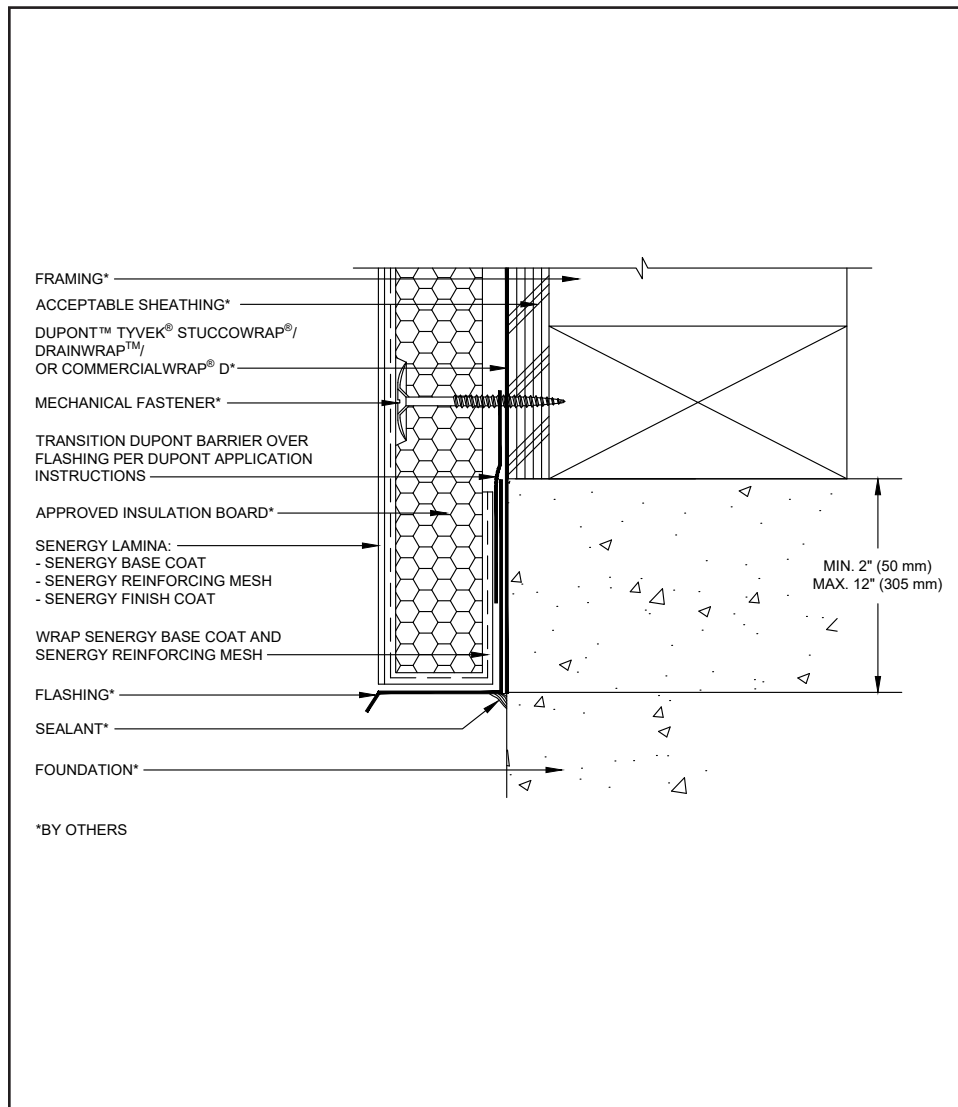

- All terminations must be fully encapsulated with mesh reinforced base coat. Prebackwrapping is recommended at drainage terminations. Extend reinforcing mesh a minimum of 2 1/2" onto back of insulation board.
- Ensure a means for drainage is provided at system termination at foundation.
- Terminate system a minimum of 6" (152 mm) above grade.
- Extend system a minimum of 2" (50 mm) and a maximum of 12" (305 mm) at the sole plate foundation transition.

23 0524

(*NOTE: BY OTHERS)

The details within are the latest recommendations and are represented in good faith by Sika Corporation US (hereinafter Sika). The details are subject to change without notice. Sika accepts no liability for the end use of the details. For conditions not shown, consult Sika for review of specific details.

- Install Sika materials in accordance with current installation instructions.
- Unsatisfactory conditions shall be reported to the General Contractor and corrected before the application of Sika products.

Senturion I System

TYPICAL TERMINATION AT FOUNDATION W/ STARTER TRACK

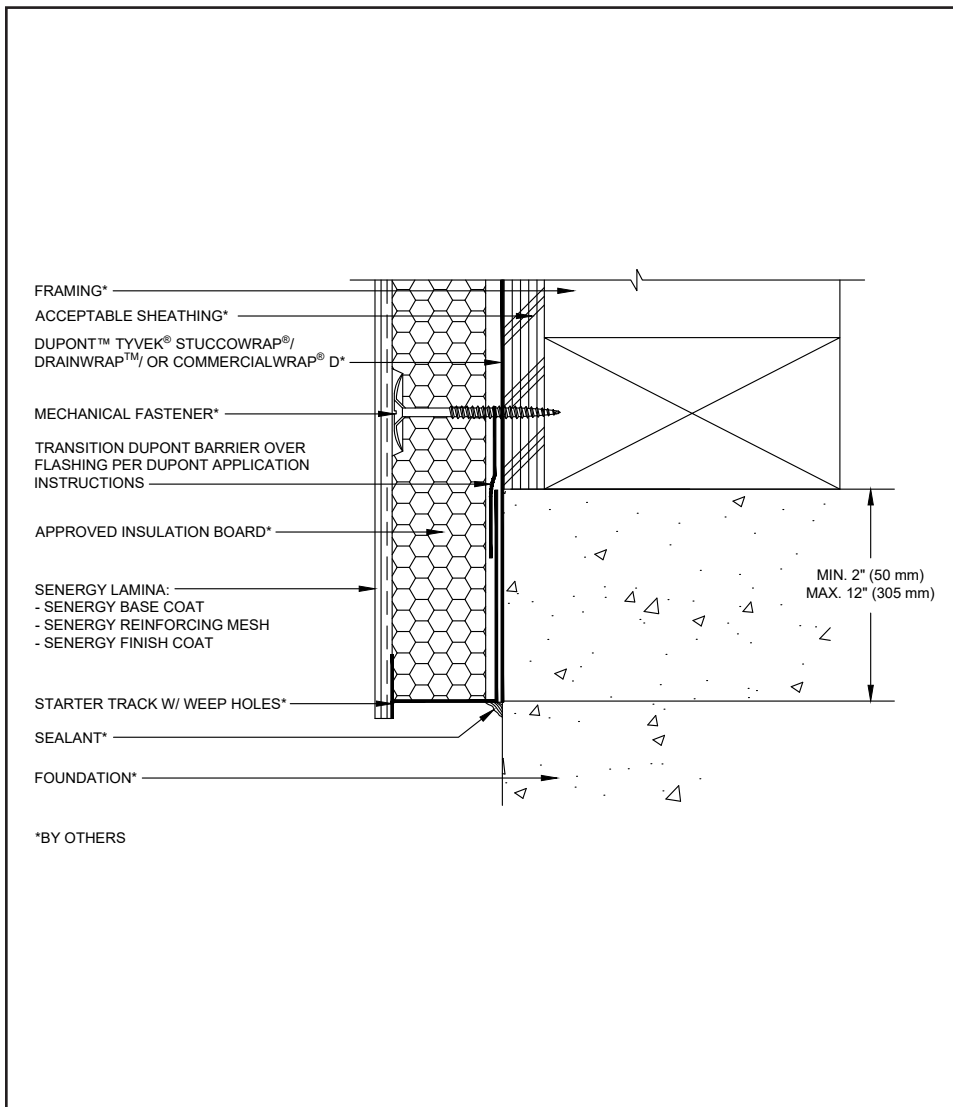

- Use of starter track is acceptable at termination at foundation only.
- Ensure a means for drainage is provided at system termination at foundation.
- Terminate system a minimum of 6" (152 mm) above grade.
- Extend system a minimum of 2" (50 mm) and a maximum of 12" (305 mm) at the sole plate foundation transition.

24 0524

(*NOTE: BY OTHERS)

The details within are the latest recommendations and are represented in good faith by Sika Corporation US (hereinafter Sika). The details are subject to change without notice. Sika accepts no liability for the end use of the details. For conditions not shown, consult Sika for review of specific details.

- Install Sika materials in accordance with current installation instructions.
- Unsatisfactory conditions shall be reported to the General Contractor and corrected before the application of Sika products.

Senturion I System

TYPICAL TERMINATION AT BRICK W/ DRAINAGE

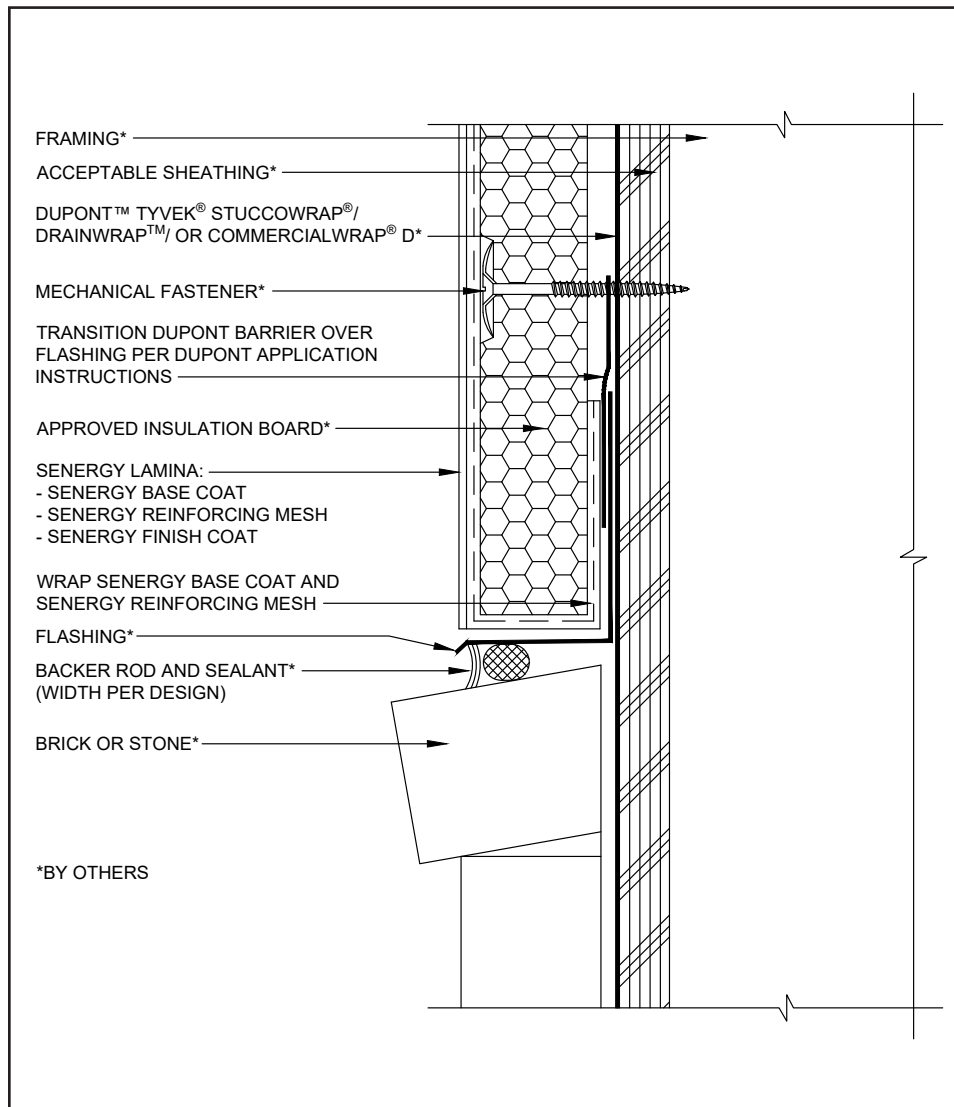

- All terminations must be fully encapsulated with mesh reinforced base coat. Prebackwrapping is recommended at drainage terminations. Extend reinforcing mesh a minimum of 2 ½" onto back of insulation board.
- Ensure a means for drainage is provided at system termination at brick.
- Brick must be installed per local code requirements.

25 0524

(*NOTE: BY OTHERS)

The details within are the latest recommendations and are represented in good faith by Sika Corporation US (hereinafter Sika). The details are subject to change without notice. Sika accepts no liability for the end use of the details. For conditions not shown, consult Sika for review of specific details.

- Install Sika materials in accordance with current installation instructions.
- Unsatisfactory conditions shall be reported to the General Contractor and corrected before the application of Sika products.

Senturion I System

TYPICAL TERMINATION AT BRICK W/ SEALANT

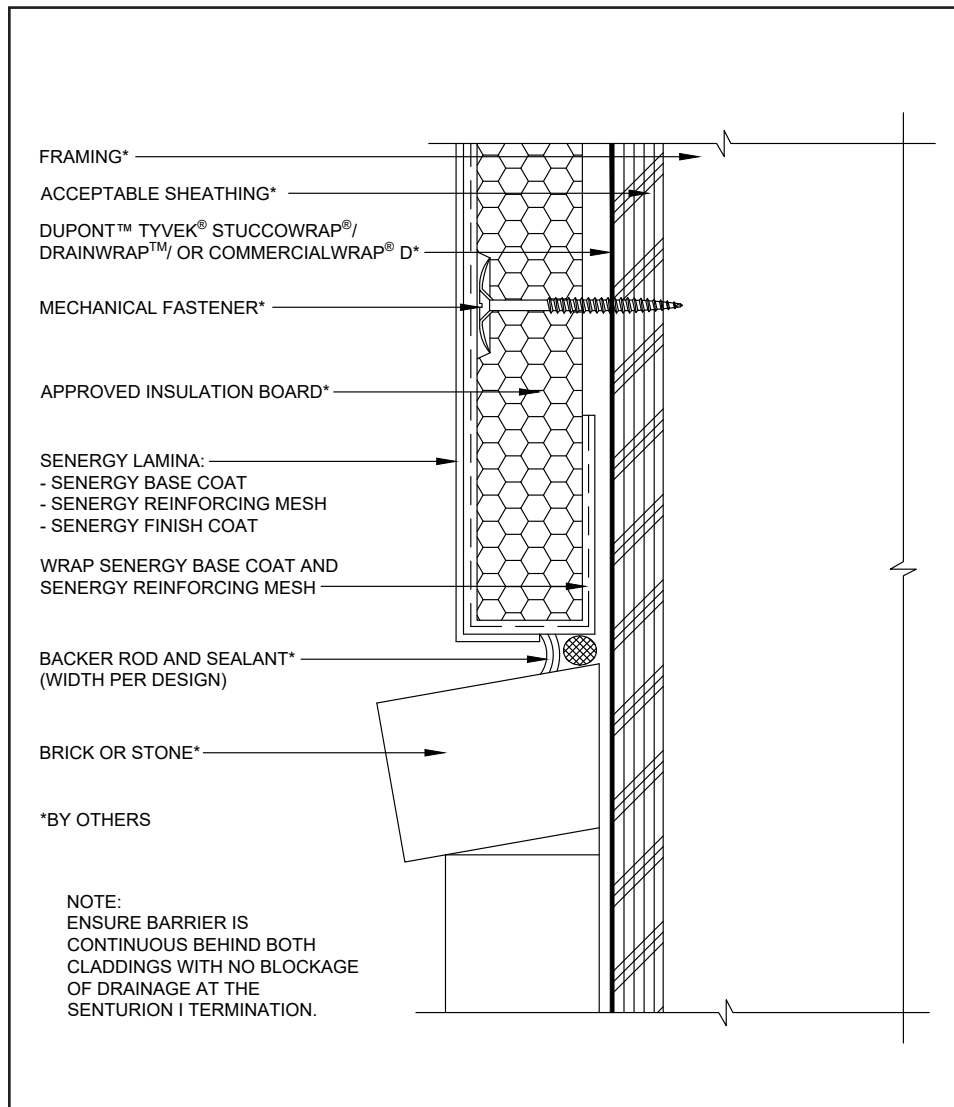

- All terminations must be fully encapsulated with mesh reinforced base coat. Prebackwrapping is recommended at drainage terminations. Extend reinforcing mesh a minimum of 2 ½" onto back of insulation board.
- Ensure a continuous drainage plane is maintained at system abutment to brick.
- Brick must be installed per local code requirements.

26 0524

(*NOTE: BY OTHERS)

The details within are the latest recommendations and are represented in good faith by Sika Corporation US (hereinafter Sika). The details are subject to change without notice. Sika accepts no liability for the end use of the details. For conditions not shown, consult Sika for review of specific details.

- Install Sika materials in accordance with current installation instructions.
- Unsatisfactory conditions shall be reported to the General Contractor and corrected before the application of Sika products.

Senturion I System

TYPICAL KICK-OUT FLASHING AT SLOPED ROOF

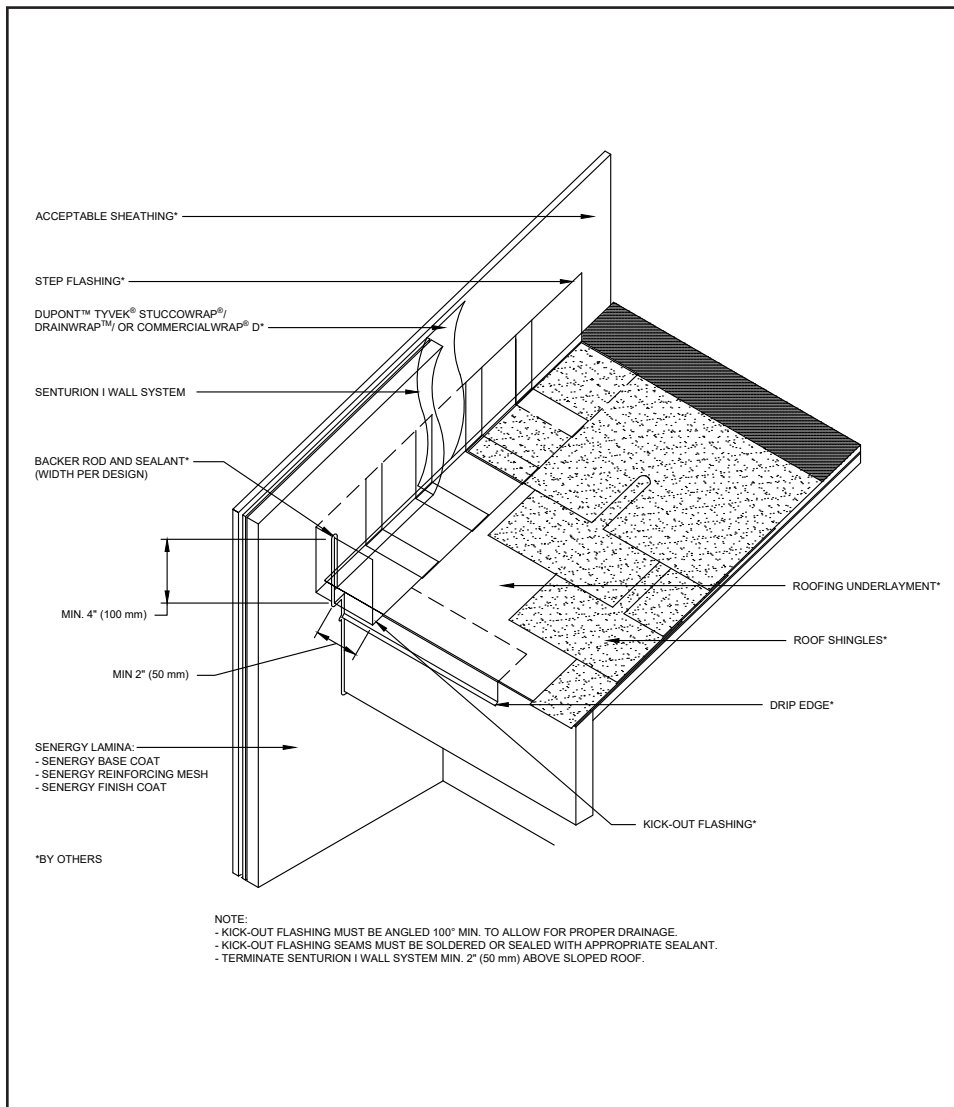

27 0524

(*NOTE: BY OTHERS)

- All terminations must be fully encapsulated with mesh reinforced base coat. Pre-backwrapping is recommended at drainage terminations. Extend reinforcing mesh a minimum of 2 ½" onto back of insulation board.
- Ensure a means for drainage is provided at system termination at roof.
- Terminate system a minimum of 2" (50 mm) above sloped roof.
- Ensure step flashing is a minimum of 2" (50 mm) behind system.
- Kick-out flashing shall be a minimum of 4" (102 mm) in height.
- Do not apply finish to areas that will receive sealant.
- Reference *Acceptable Sealants for use with Senergy Wall Systems* Technical Bulletin for a list of sealants.

The details within are the latest recommendations and are represented in good faith by Sika Corporation US (hereinafter Sika). The details are subject to change without notice. Sika accepts no liability for the end use of the details. For conditions not shown, consult Sika for review of specific details.

- Install Sika materials in accordance with current installation instructions.
- Unsatisfactory conditions shall be reported to the General Contractor and corrected before the application of Sika products.



LIMITED WARRANTY NOTICE

Prior to each use of any product of Sika Corporation, its subsidiaries or affiliates ("SIKA"), the user must always read and follow the warnings and instructions on the product's most current product label, Product Data Sheet and Safety Data Sheet which are available at usa.sika.com/senenergy or by calling our Technical Service Department at +1 (800) 589-1336.

Nothing contained in any SIKA literature or materials relieves the user of the obligation to read and follow the warnings and instructions for each SIKA product as set forth in the current product label, Product Data Sheet and Safety Data Sheet prior to use of the SIKA product.

SIKA warrants this product for one year from date of installation to be free from manufacturing defects and to meet the technical properties on the current Product Data Sheet if used as directed within the product's shelf life. User determines suitability of product for intended use and assumes all risks. User's and/or buyer's sole remedy shall be limited to the purchase price or replacement of this product exclusive of any labor costs. NO OTHER WARRANTIES EXPRESS OR IMPLIED SHALL APPLY INCLUDING ANY WARRANTY OF MERCHANTABILITY OR FITNESS FOR A PARTICULAR PURPOSE. SIKA SHALL NOT BE LIABLE UNDER ANY LEGAL THEORY FOR SPECIAL OR CONSEQUENTIAL DAMAGES. SIKA SHALL NOT BE RESPONSIBLE FOR THE USE OF THIS PRODUCT IN A MANNER TO INFRINGE ON ANY PATENT OR ANY OTHER INTELLECTUAL PROPERTY RIGHTS HELD BY OTHERS. Sale of SIKA products are subject to the Terms and Conditions of Sale which are available at usa.sika.com.

For the most current version of this literature, please visit our website at usa.sika.com/senergy.

Sika Corporation
201 Polito Avenue
Lyndhurst, NJ 07071 USA
Customer Service +1 (800) 433-9517
Technical Service +1 (800) 589-1336
usa.sika.com/senergy
Rev May 2024

BUILDING TRUST

