

Senergy®



Senerflex Classic PB

Class PB Exterior Insulation and
Finish System

Typical Details

BUILDING TRUST



Senerflex Classic PB

Typical Details

Class PB Exterior Insulation and Finish System

TABLE OF CONTENTS

1. Senerflex Wall System Application
2. Aesthetic Reveal
3. Window Head (Flush)
4. Window Head (Recessed)
5. Window Jamb (Flush)
6. Window Jamb (Recessed)
7. Window Sill (Flush)
8. Window Sill (Recessed)
9. Roof Edge Flashing
10. Parapet Cap Flashing
11. Parapet Cap
12. Expansion Joint at Floorline
13. Expansion Joint at Change in Substrate
14. Transition at Soffit / Gable End
15. Expansion Joint
16. Pipe Penetration
17. Corner Mesh
18. Light Fixture
19. Termination at Foundation
20. Termination at Foundation (Flush)
21. Kick-Out Flashing

Notes:

- **The details within represent Sika Corporation US (hereinafter Sika) latest recommendations. They are presented in good faith by Sika. The details are subject to change without notice. Sika accepts no liability for the end use of the details. For conditions not shown, consult Sika for review of specific detail.**
- **Install Sika materials in accordance with current installation instructions.**
- **Unsatisfactory conditions shall be reported to the General Contractor and corrected before the application of Sika products.**

Senergy Classic PB

TYPICAL SENERFLEX WALL SYSTEM APPLICATION

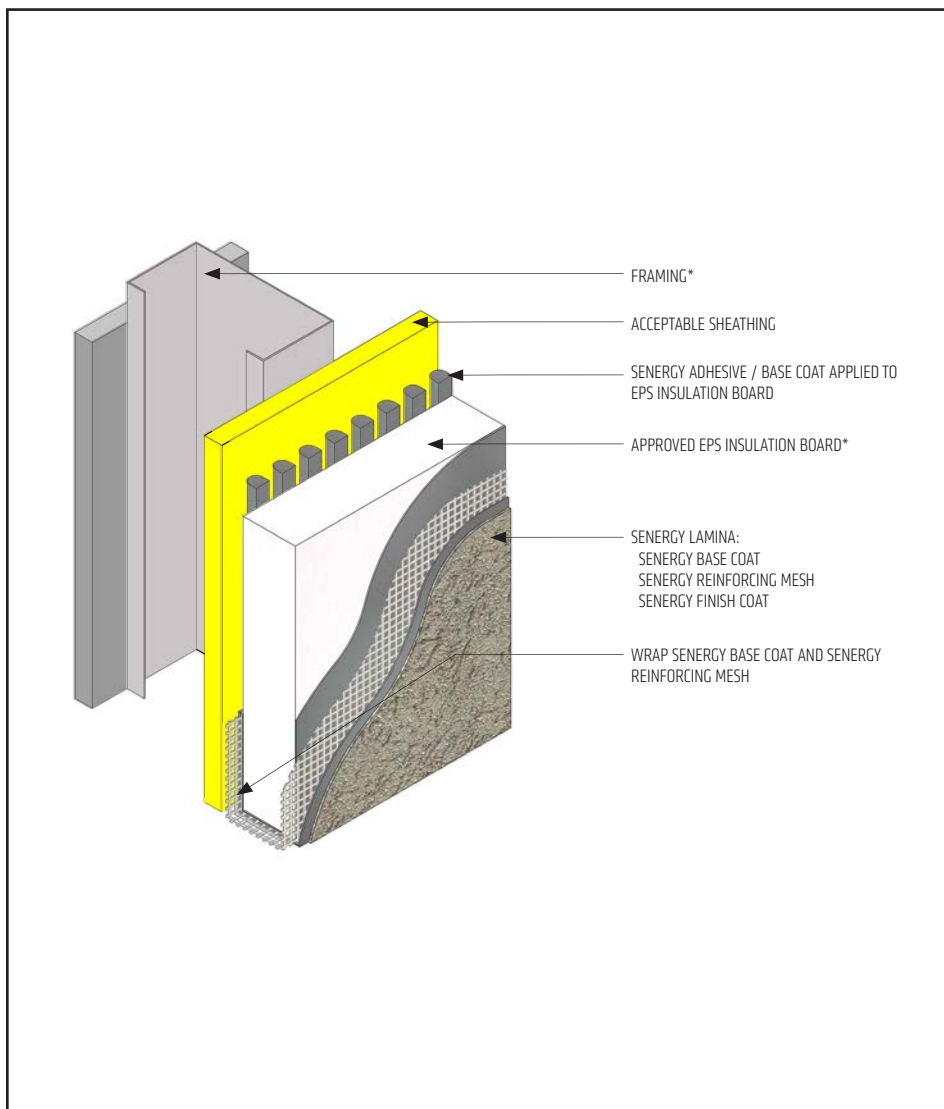

- All terminations must be fully encapsulated with mesh reinforced base coat.

PB-01 2401

(*NOTE: BY OTHERS)

The details within are the latest recommendations and are represented in good faith by Sika Corporation US (hereinafter Sika). The details are subject to change without notice. Sika accepts no liability for the end use of the details. For conditions not shown, consult Sika for review of specific details.

- Install Sika materials in accordance with current installation instructions.
- Unsatisfactory conditions shall be reported to the General Contractor and corrected before the application of Sika products.

Senergy Classic PB

TYPICAL AESTHETIC REVEAL

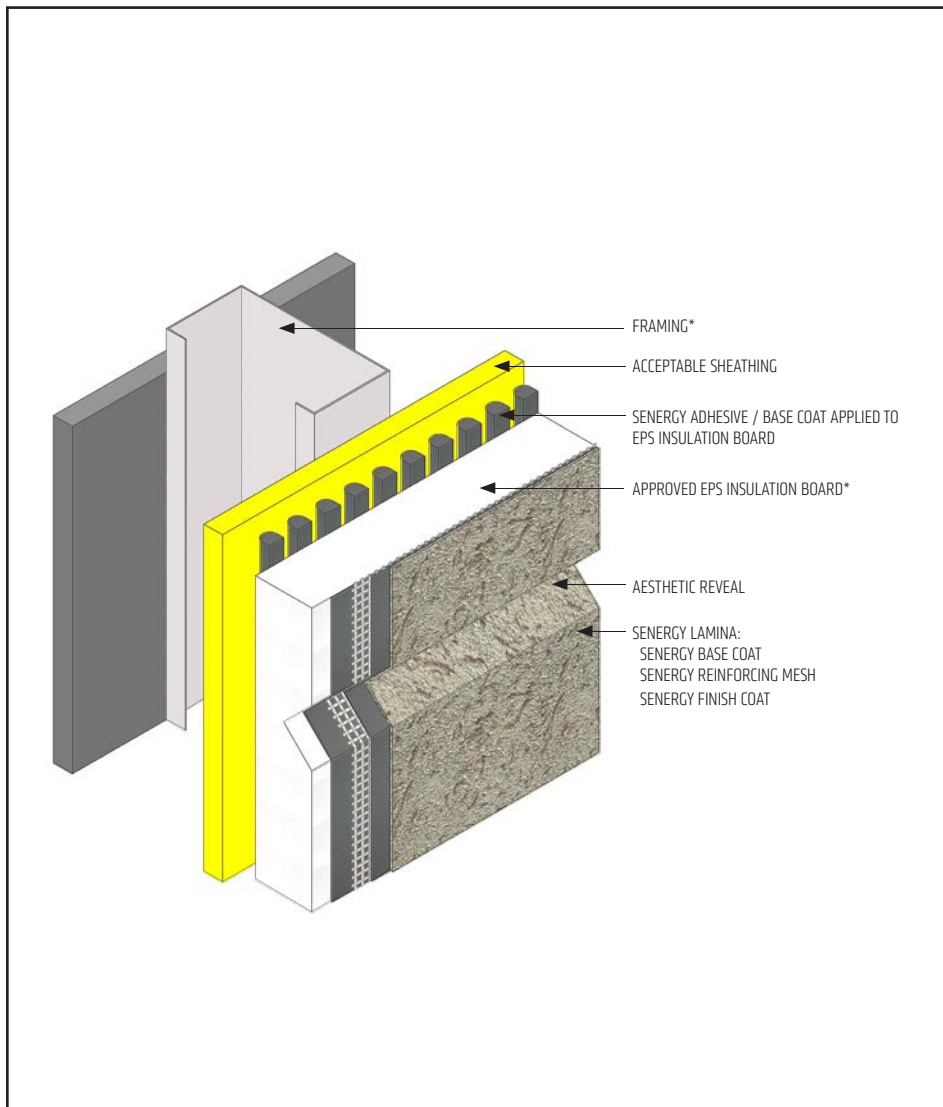

- Maintain a minimum 3/4" (19 mm) thick EPS insulation board behind all reveals and aesthetic grooves.
- Reinforcing mesh shall be continuous through the reveal and care shall be taken to ensure reinforcing mesh is encapsulated into the reveal and is not cut during base coat application.
- Horizontal reveals shall provide an outward positive drainage.
- Reveals must not occur at the abutment of two pieces of EPS insulation board.
- Reveals must not occur at the joints in sheathing.

PB-02 2401

(*NOTE: BY OTHERS)

The details within are the latest recommendations and are represented in good faith by Sika Corporation US (hereinafter Sika). The details are subject to change without notice. Sika accepts no liability for the end use of the details. For conditions not shown, consult Sika for review of specific details.

- Install Sika materials in accordance with current installation instructions.
- Unsatisfactory conditions shall be reported to the General Contractor and corrected before the application of Sika products.

Senerflex Classic PB

TYPICAL WINDOW HEAD (FLUSH)

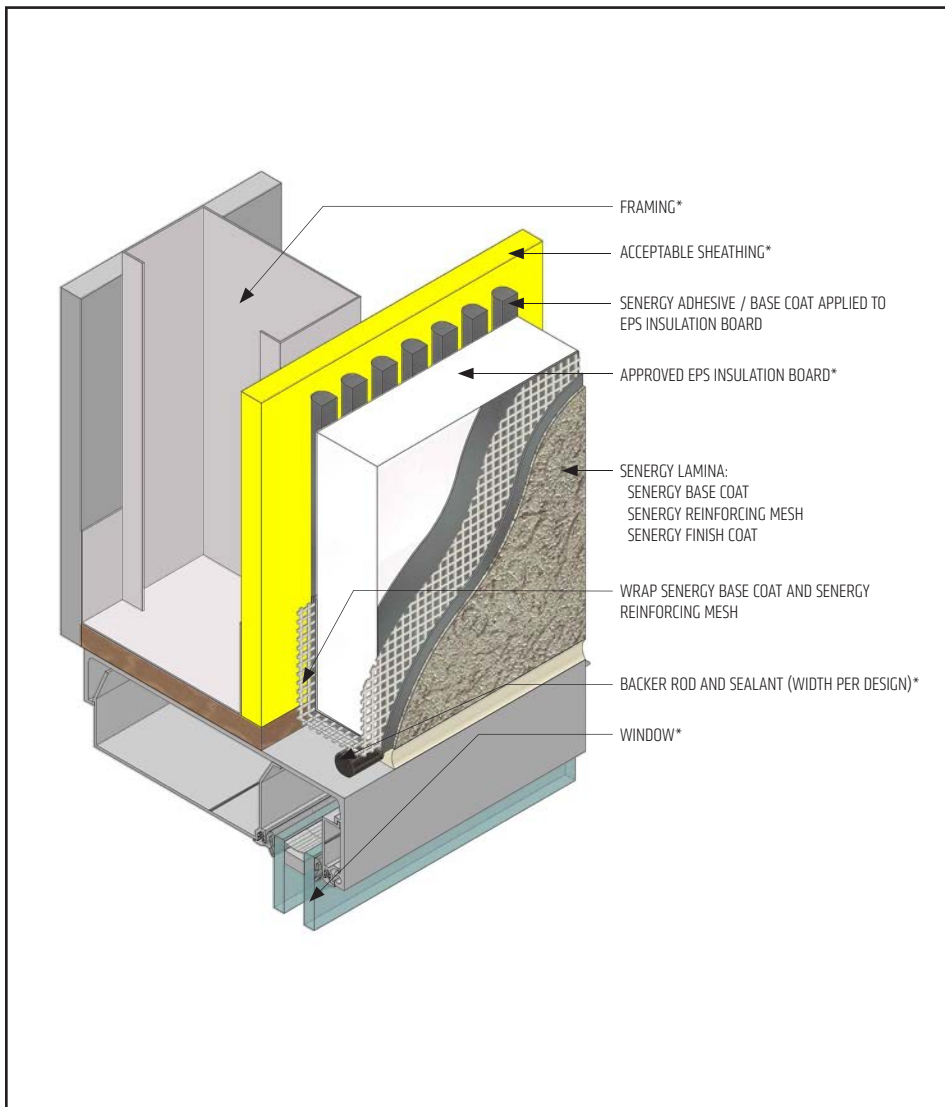

- All terminations must be fully encapsulated with mesh reinforced base coat.
- Do not apply finish to areas that will receive sealant.
- Provide a properly configured back wrapped joint with backer rod and sealant at system terminations to dissimilar materials, ensuring that a watertight seal is achieved.
- Joint and EPS insulation board must not line up with corner of rough openings.

PB-03 2401

(*NOTE: BY OTHERS)

The details within are the latest recommendations and are represented in good faith by Sika Corporation US (hereinafter Sika). The details are subject to change without notice. Sika accepts no liability for the end use of the details. For conditions not shown, consult Sika for review of specific details.

- Install Sika materials in accordance with current installation instructions.
- Unsatisfactory conditions shall be reported to the General Contractor and corrected before the application of Sika products.

Senerflex Classic PB

TYPICAL WINDOW HEAD (RECESSED)

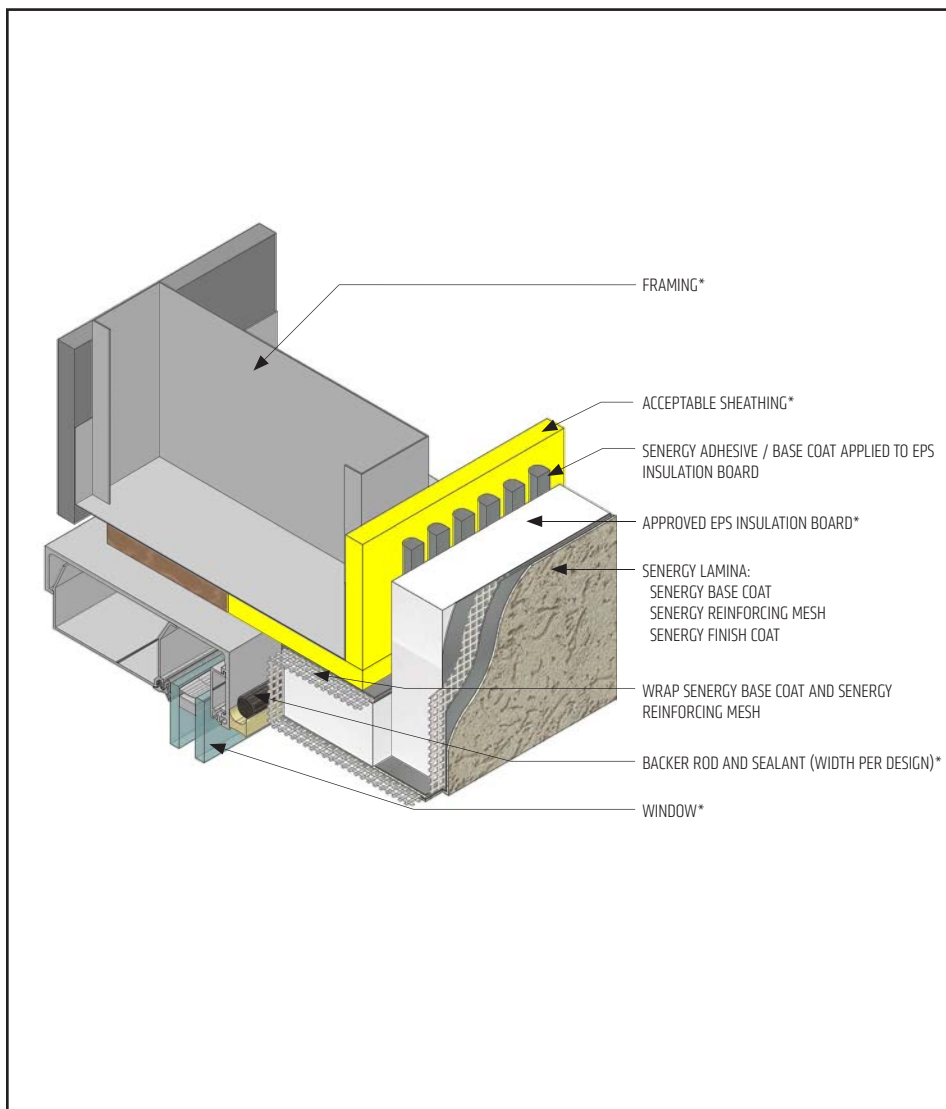

- All terminations must be fully encapsulated with mesh reinforced base coat.
- Do not apply finish to areas that will receive sealant.
- Provide a properly configured back wrapped joint with backer rod and sealant at system terminations to dissimilar materials, ensuring that a watertight seal is achieved.
- Joint and EPS insulation board must not line up with corner of rough openings.

PB-04 2401

(*NOTE: BY OTHERS)

The details within are the latest recommendations and are represented in good faith by Sika Corporation US (hereinafter Sika). The details are subject to change without notice. Sika accepts no liability for the end use of the details. For conditions not shown, consult Sika for review of specific details.

- Install Sika materials in accordance with current installation instructions.
- Unsatisfactory conditions shall be reported to the General Contractor and corrected before the application of Sika products.

Senerflex Classic PB

TYPICAL WINDOW JAMB (FLUSH)

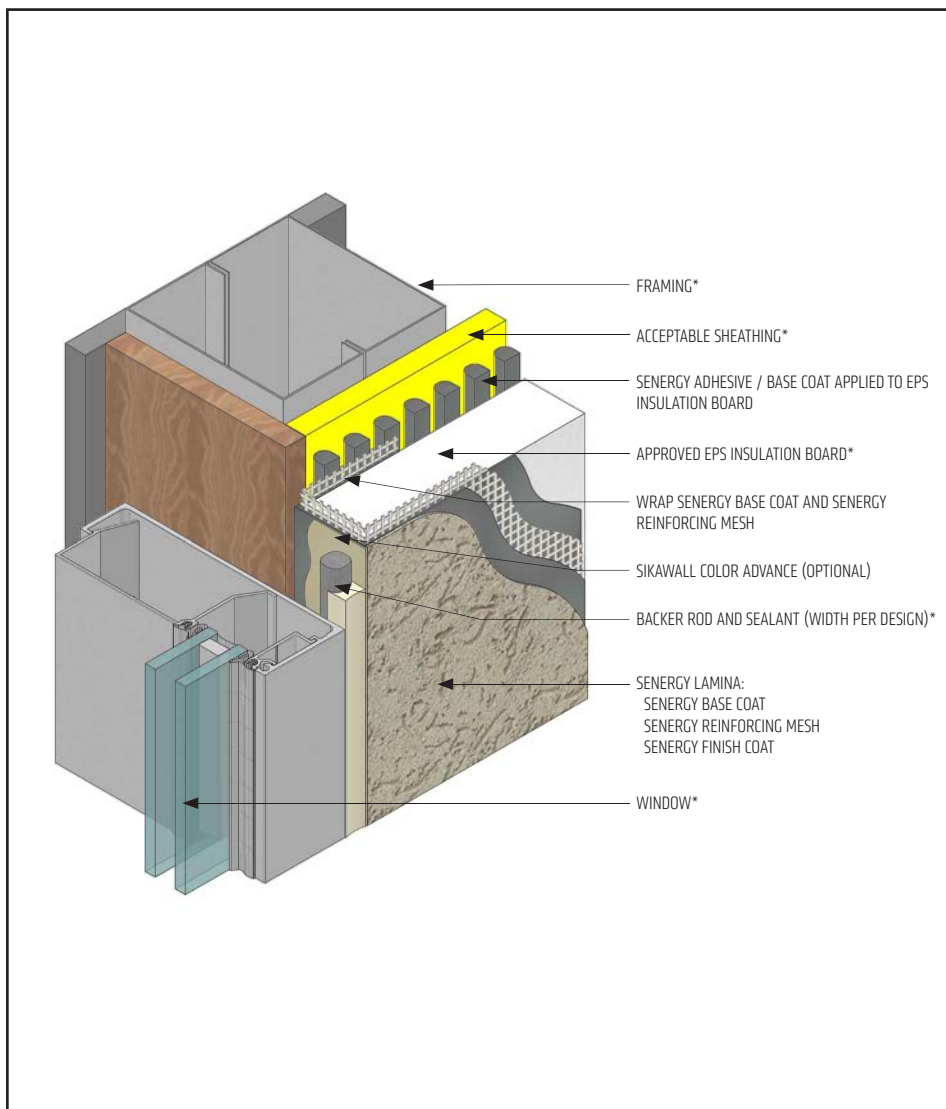

- All terminations must be fully encapsulated with mesh reinforced base coat.
- Do not apply finish to areas that will receive sealant.
- Provide a properly configured back wrapped joint with backer rod and sealant at system terminations to dissimilar materials, ensuring that a watertight seal is achieved.
- Joint and EPS insulation board must not line up with corner of rough openings.

PB-05 2401

(*NOTE: BY OTHERS)

The details within are the latest recommendations and are represented in good faith by Sika Corporation US (hereinafter Sika). The details are subject to change without notice. Sika accepts no liability for the end use of the details. For conditions not shown, consult Sika for review of specific details.

- Install Sika materials in accordance with current installation instructions.
- Unsatisfactory conditions shall be reported to the General Contractor and corrected before the application of Sika products.

Senerflex Classic PB

TYPICAL WINDOW JAMB (RECESSED)

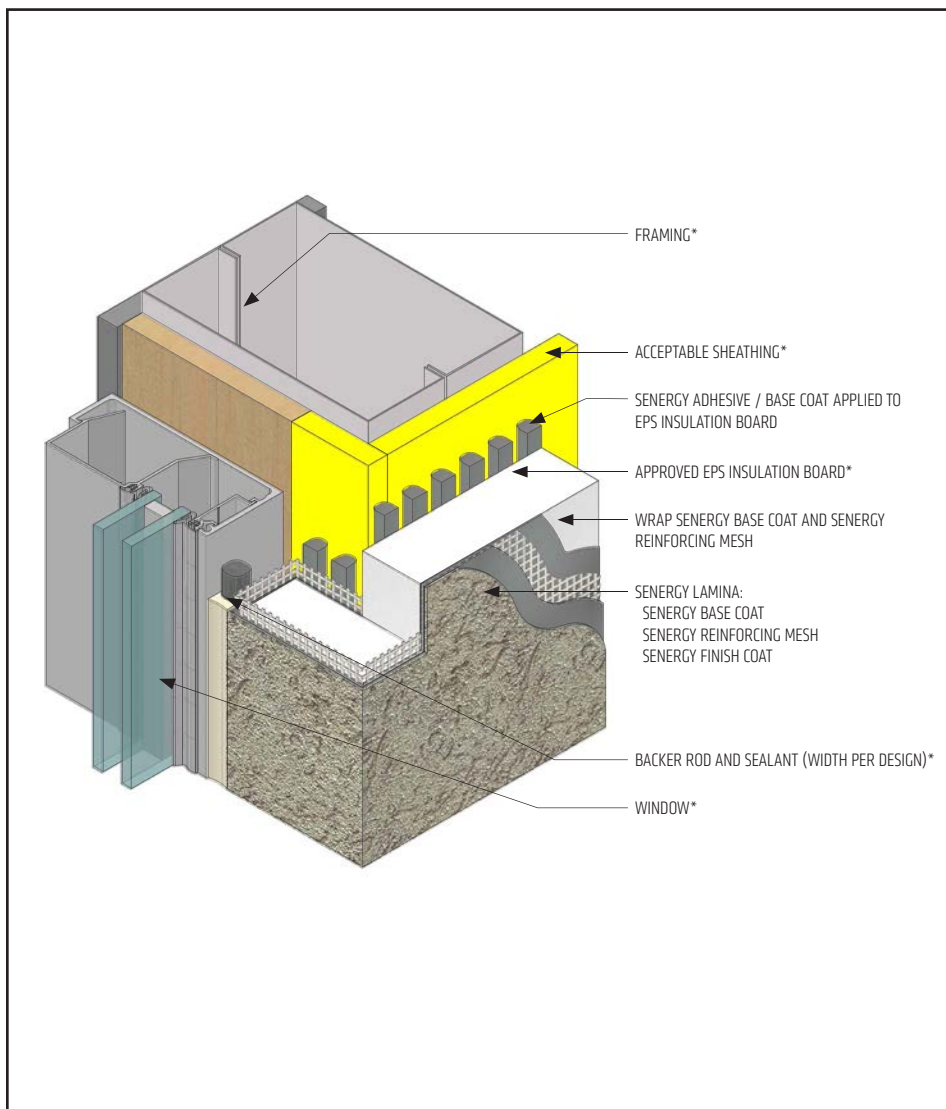

- All terminations must be fully encapsulated with mesh reinforced base coat.
- Do not apply finish to areas that will receive sealant.
- Provide a properly configured back wrapped joint with backer rod and sealant at system terminations to dissimilar materials, ensuring that a watertight seal is achieved.
- Joint and EPS insulation board must not line up with corner of rough openings.

PB-06 2401

(*NOTE: BY OTHERS)

The details within are the latest recommendations and are represented in good faith by Sika Corporation US (hereinafter Sika). The details are subject to change without notice. Sika accepts no liability for the end use of the details. For conditions not shown, consult Sika for review of specific details.

- Install Sika materials in accordance with current installation instructions.
- Unsatisfactory conditions shall be reported to the General Contractor and corrected before the application of Sika products.

Senerflex Classic PB

TYPICAL WINDOW SILL (FLUSH)

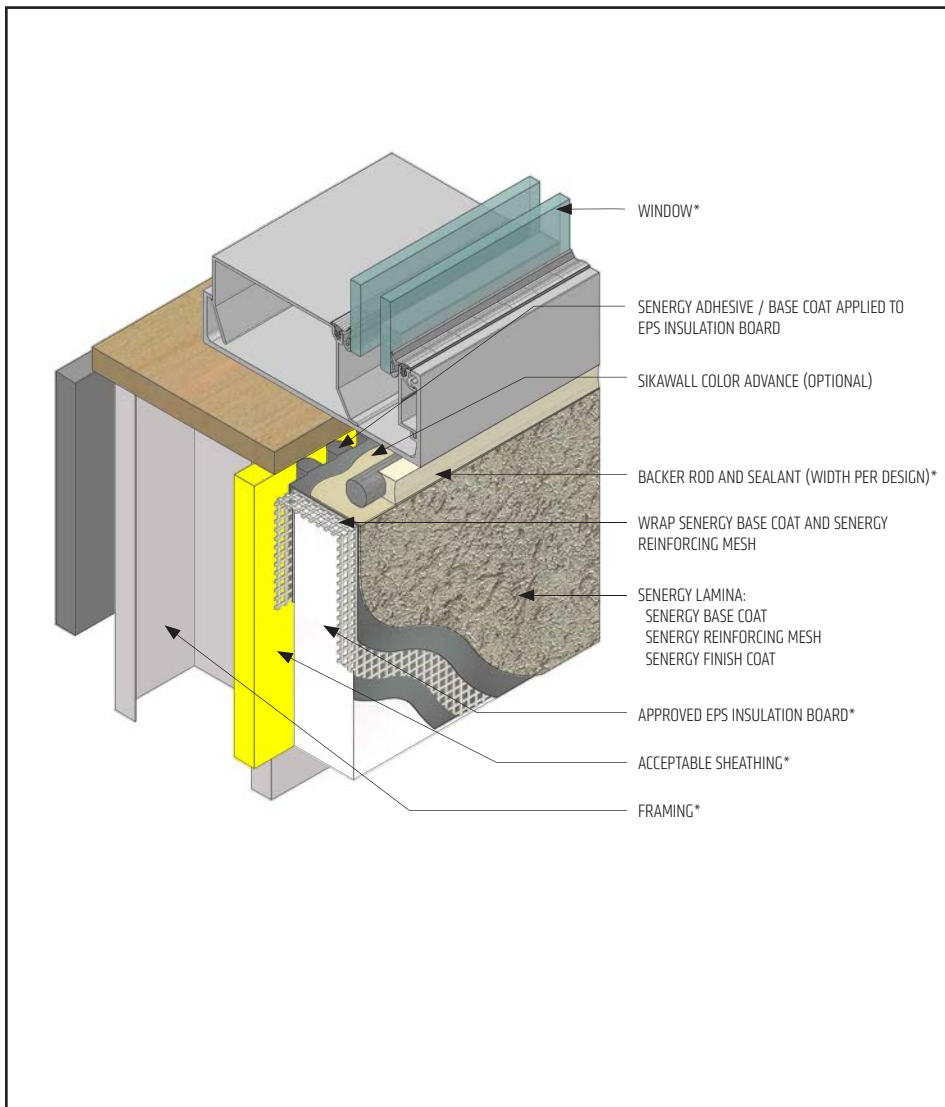

- All terminations must be fully encapsulated with mesh reinforced base coat.
- Do not apply finish to areas that will receive sealant.
- Provide a properly configured back wrapped joint with backer rod and sealant at system terminations to dissimilar materials, ensuring that a watertight seal is achieved.
- Joint and EPS insulation board must not line up with corner of rough openings.

PB-07 2401

(*NOTE: BY OTHERS)

The details within are the latest recommendations and are represented in good faith by Sika Corporation US (hereinafter Sika). The details are subject to change without notice. Sika accepts no liability for the end use of the details. For conditions not shown, consult Sika for review of specific details.

- Install Sika materials in accordance with current installation instructions.
- Unsatisfactory conditions shall be reported to the General Contractor and corrected before the application of Sika products.

Senerflex Classic PB

TYPICAL WINDOW SILL (RECESSED)

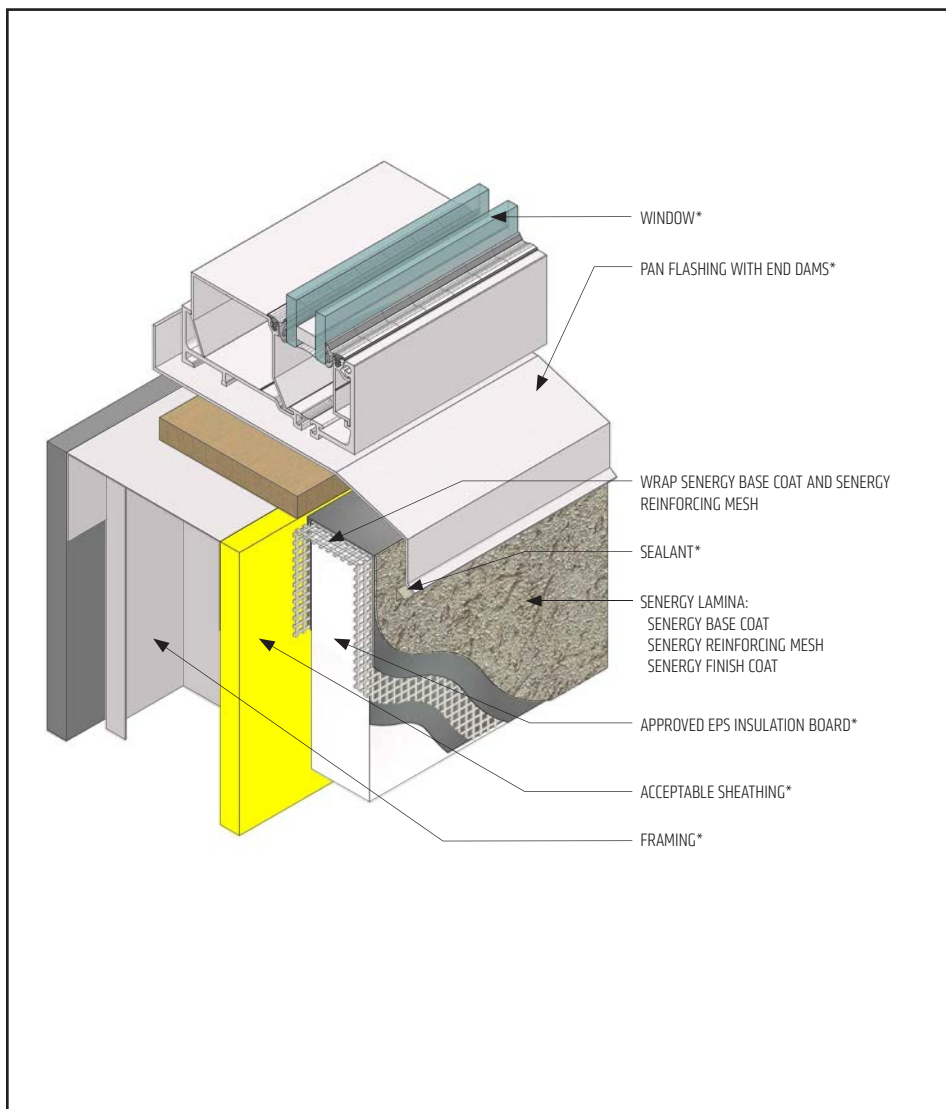

- All terminations must be fully encapsulated with mesh reinforced base coat.
- Do not apply finish to areas that will receive sealant.
- Provide a properly configured back wrapped joint with backer rod and sealant at system terminations to dissimilar materials, ensuring that a watertight seal is achieved.
- Joint and EPS insulation board must not line up with corner of rough openings.
- Ensure flashing extends onto the system a minimum of 2" (51 mm) and that flange is sealed.

PB-08 2401

(*NOTE: BY OTHERS)

The details within are the latest recommendations and are represented in good faith by Sika Corporation US (hereinafter Sika). The details are subject to change without notice. Sika accepts no liability for the end use of the details. For conditions not shown, consult Sika for review of specific details.

- Install Sika materials in accordance with current installation instructions.
- Unsatisfactory conditions shall be reported to the General Contractor and corrected before the application of Sika products.

Senerflex Classic PB

TYPICAL ROOF EDGE FLASHING

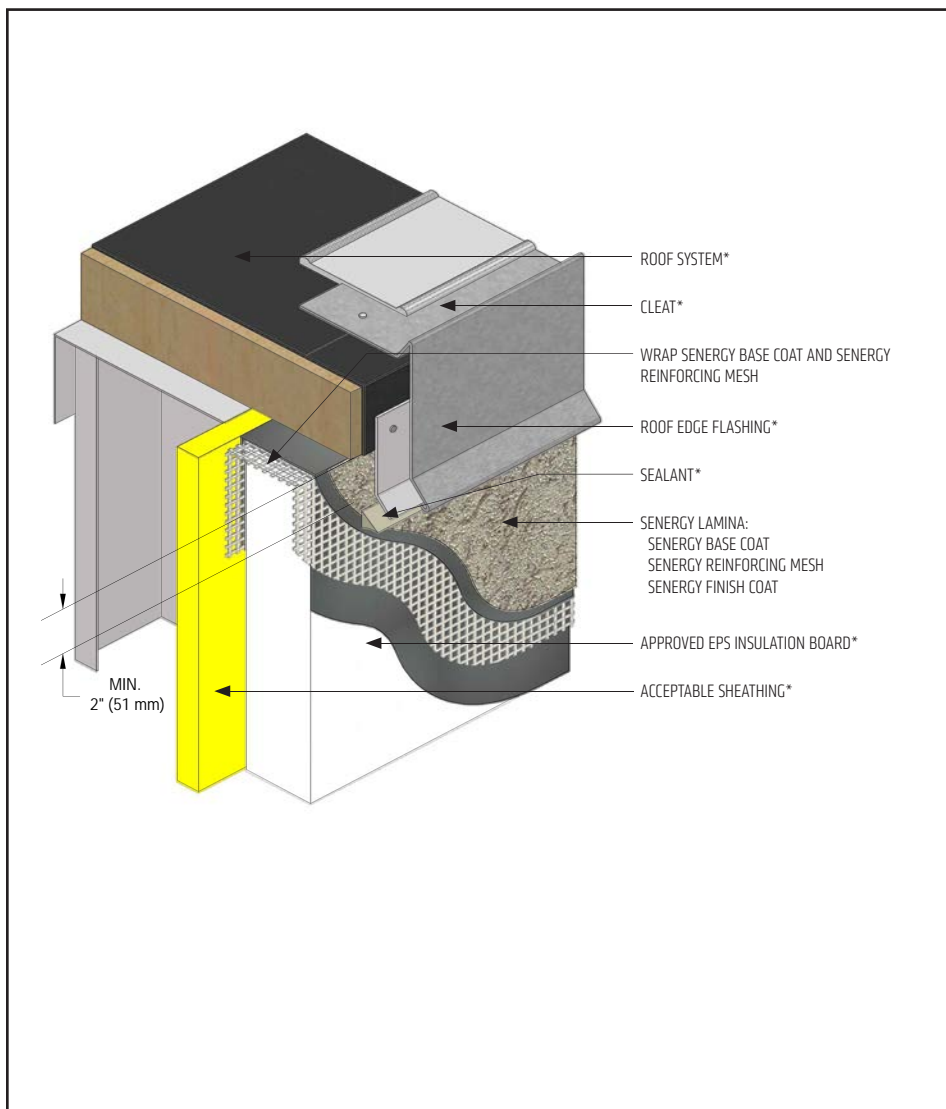

- All terminations must be fully encapsulated with mesh reinforced base coat.
- Ensure that metal coping/flashing extends onto the system a minimum of 2" (51 mm) and that the flange is sealed.

PB-09 2401

(*NOTE: BY OTHERS)

The details within are the latest recommendations and are represented in good faith by Sika Corporation US (hereinafter Sika). The details are subject to change without notice. Sika accepts no liability for the end use of the details. For conditions not shown, consult Sika for review of specific details.

- Install Sika materials in accordance with current installation instructions.
- Unsatisfactory conditions shall be reported to the General Contractor and corrected before the application of Sika products.

Senerflex Classic PB

TYPICAL PARAPET CAP FLASHING

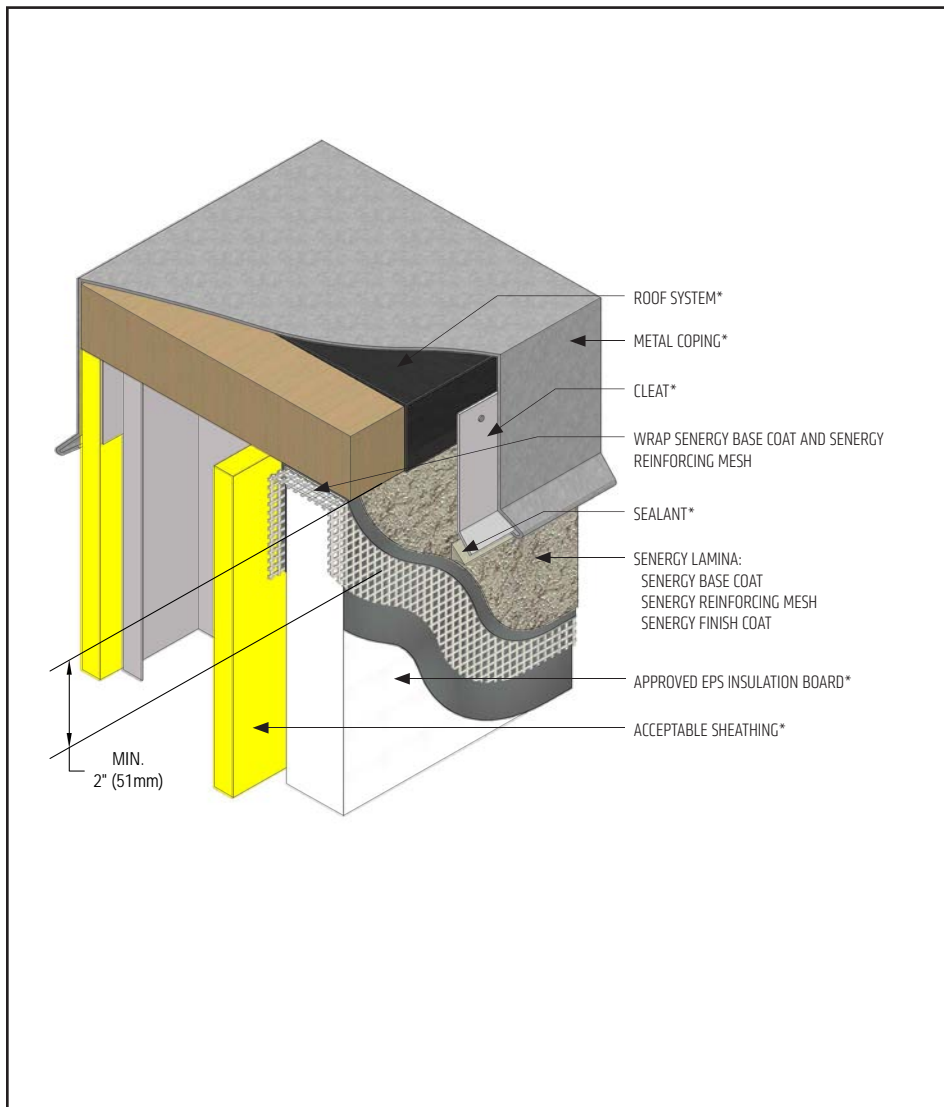

- All terminations must be fully encapsulated with mesh reinforced base coat.
- Ensure that metal coping/flashing extends onto the system a minimum of 2" (51 mm) and that the flange is sealed.

PB-10 2401

(*NOTE: BY OTHERS)

The details within are the latest recommendations and are represented in good faith by Sika Corporation US (hereinafter Sika). The details are subject to change without notice. Sika accepts no liability for the end use of the details. For conditions not shown, consult Sika for review of specific details.

- Install Sika materials in accordance with current installation instructions.
- Unsatisfactory conditions shall be reported to the General Contractor and corrected before the application of Sika products.

Senerflex Classic PB

TYPICAL PARAPET CAP

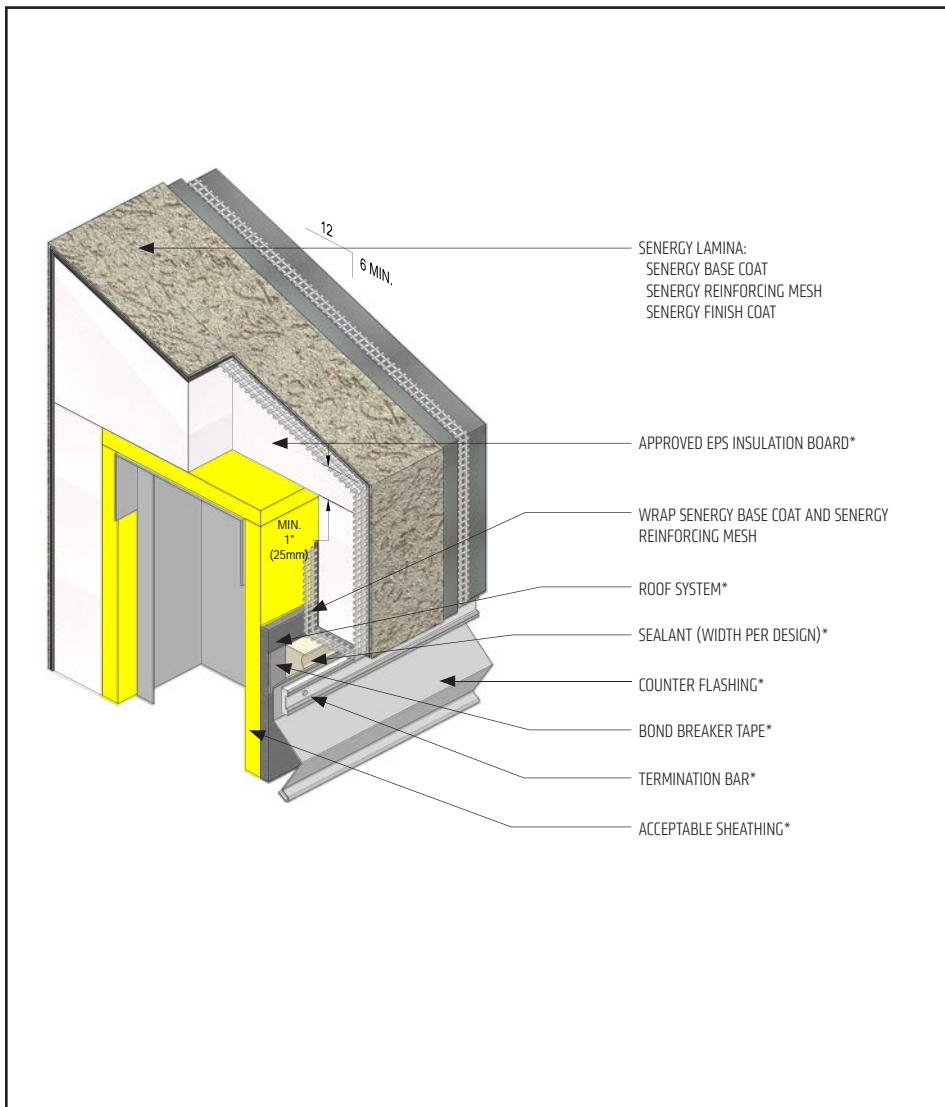

- All terminations must be fully encapsulated with mesh reinforced base coat.
- Provide a minimum 6:12 slope for all horizontal surfaces greater than 1" (25 mm). Senergy requires the use of a roofing system or metal cap flashing for sloped surfaces over 24" (609 mm).
- Terminate system a minimum of 6" (152 mm) above roof.
- Maintain a minimum 1" (25 mm) thick EPS insulation board.

PB-11 2401

(*NOTE: BY OTHERS)

The details within are the latest recommendations and are represented in good faith by Sika Corporation US (hereinafter Sika). The details are subject to change without notice. Sika accepts no liability for the end use of the details. For conditions not shown, consult Sika for review of specific details.

- Install Sika materials in accordance with current installation instructions.
- Unsatisfactory conditions shall be reported to the General Contractor and corrected before the application of Sika products.

Senerflex Classic PB

TYPICAL EXPANSION JOINT AT FLOOR LINE

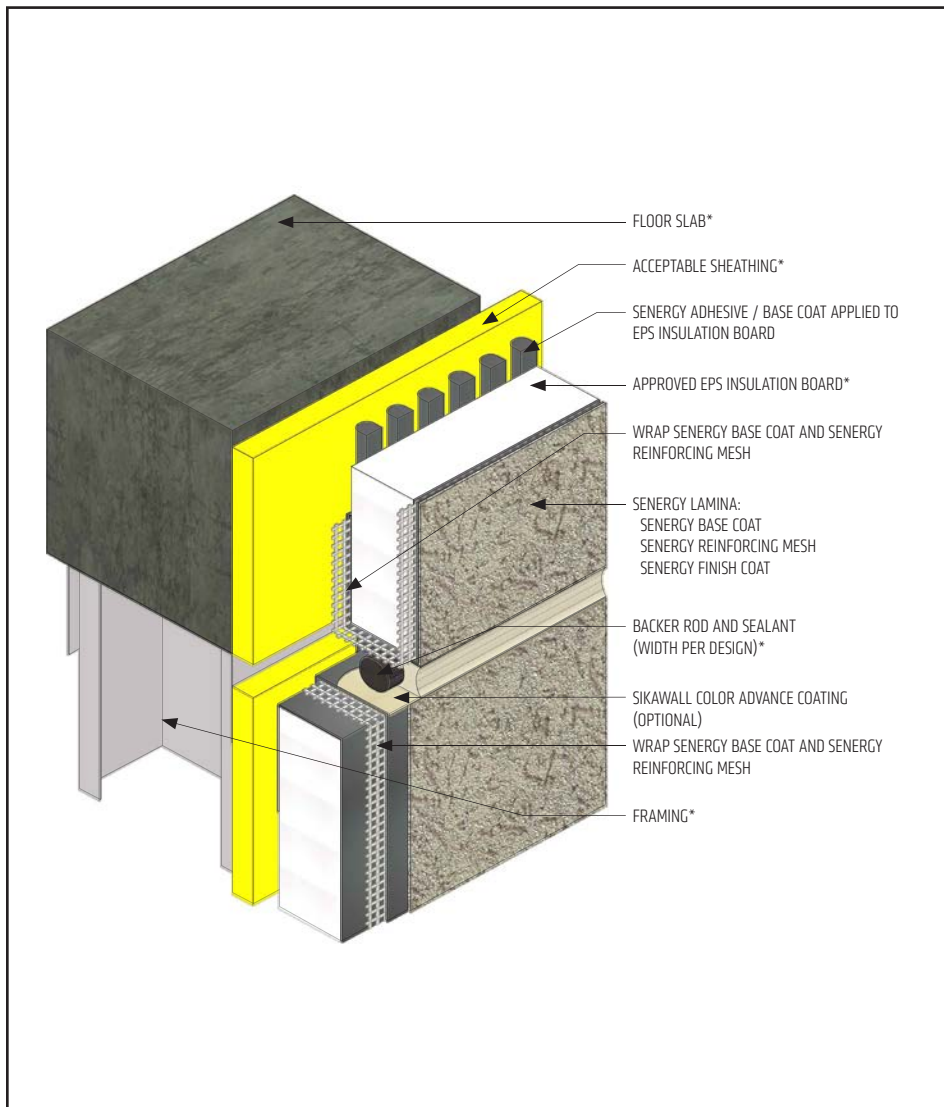

- All terminations must be fully encapsulated with mesh reinforced base coat.
- Do not apply finish to areas that will receive sealant.
- Install expansion joints in the system at all changes in substrate, through existing expansion joints, floor lines in multi-level wood frame construction, and where movement is anticipated. It is the sole responsibility of the design professional to determine specific expansion joint location, placement and design.

PB-12 2401

(*NOTE: BY OTHERS)

The details within are the latest recommendations and are represented in good faith by Sika Corporation US (hereinafter Sika). The details are subject to change without notice. Sika accepts no liability for the end use of the details. For conditions not shown, consult Sika for review of specific details.

- Install Sika materials in accordance with current installation instructions.
- Unsatisfactory conditions shall be reported to the General Contractor and corrected before the application of Sika products.

Senerflex Classic PB

TYPICAL EXPANSION JOINT AT CHANGE IN SUBSTRATE

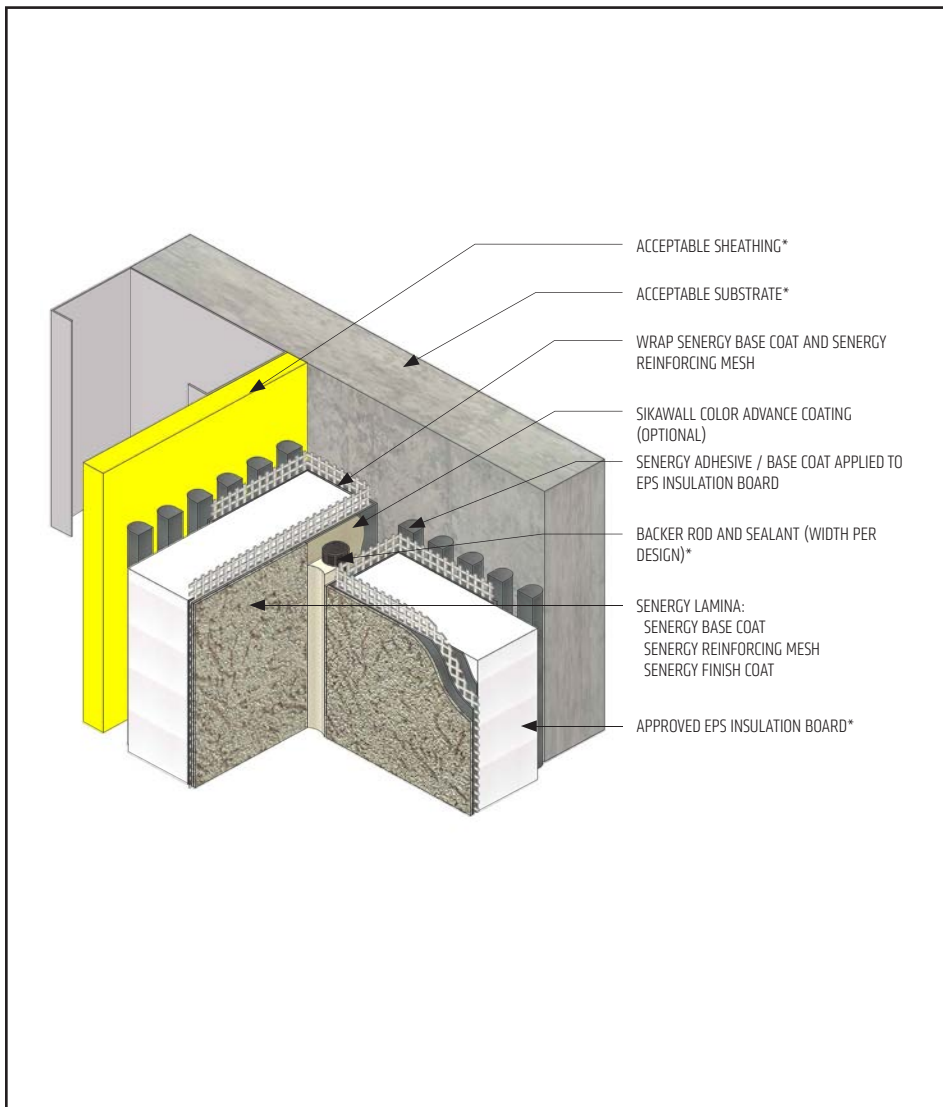

- All terminations must be fully encapsulated with mesh reinforced base coat.
- Do not apply finish to areas that will receive sealant.
- Install expansion joints in the system at all changes in substrate, through existing expansion joints, floor lines in multi-level wood frame construction, and where movement is anticipated. It is the sole responsibility of the design professional to determine specific expansion joint location, placement and design.

PB-13 2401

(*NOTE: BY OTHERS)

The details within are the latest recommendations and are represented in good faith by Sika Corporation US (hereinafter Sika). The details are subject to change without notice. Sika accepts no liability for the end use of the details. For conditions not shown, consult Sika for review of specific details.

- Install Sika materials in accordance with current installation instructions.
- Unsatisfactory conditions shall be reported to the General Contractor and corrected before the application of Sika products.

Senerflex Classic PB

TYPICAL TRANSITION AT SOFFIT AND FASCIA

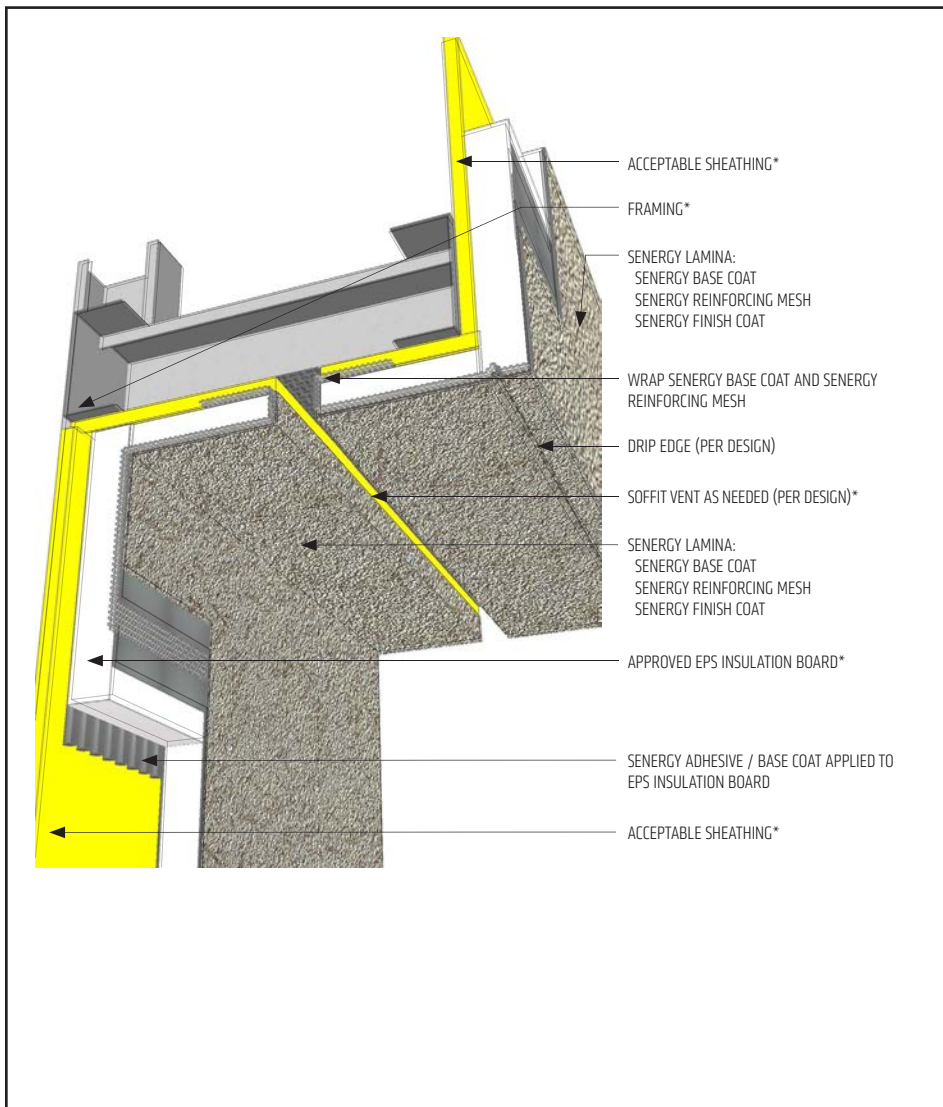

- All terminations must be fully encapsulated with mesh reinforced base coat.
- Maintain a minimum 3/4" (19 mm) thick EPS insulation board behind drip edge

PB-14 2401

(*NOTE: BY OTHERS)

The details within are the latest recommendations and are represented in good faith by Sika Corporation US (hereinafter Sika). The details are subject to change without notice. Sika accepts no liability for the end use of the details. For conditions not shown, consult Sika for review of specific details.

- Install Sika materials in accordance with current installation instructions.
- Unsatisfactory conditions shall be reported to the General Contractor and corrected before the application of Sika products.

Senerflex Classic PB

TYPICAL EXPANSION JOINT

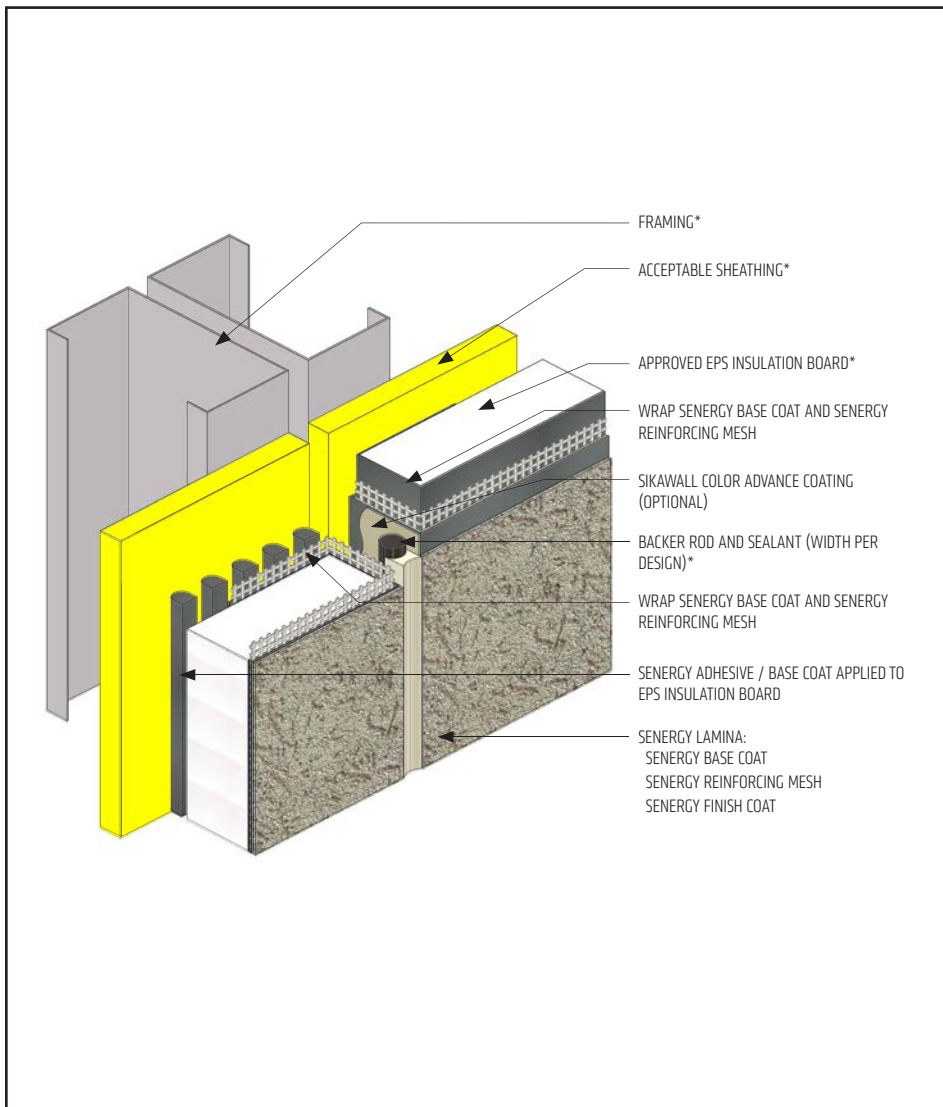

- All terminations must be fully encapsulated with mesh reinforced base coat.
- Do not apply finish to areas that will receive sealant.
- Install expansion joints in the system at all changes in substrate, through existing expansion joints, floor lines in multi-level wood frame construction, and where movement is anticipated. It is the sole responsibility of the design professional to determine specific expansion joint location, placement and design.

PB-15 2401

(*NOTE: BY OTHERS)

The details within are the latest recommendations and are represented in good faith by Sika Corporation US (hereinafter Sika). The details are subject to change without notice. Sika accepts no liability for the end use of the details. For conditions not shown, consult Sika for review of specific details.

- Install Sika materials in accordance with current installation instructions.
- Unsatisfactory conditions shall be reported to the General Contractor and corrected before the application of Sika products.

Senerflex Classic PB

TYPICAL PIPE PENETRATION

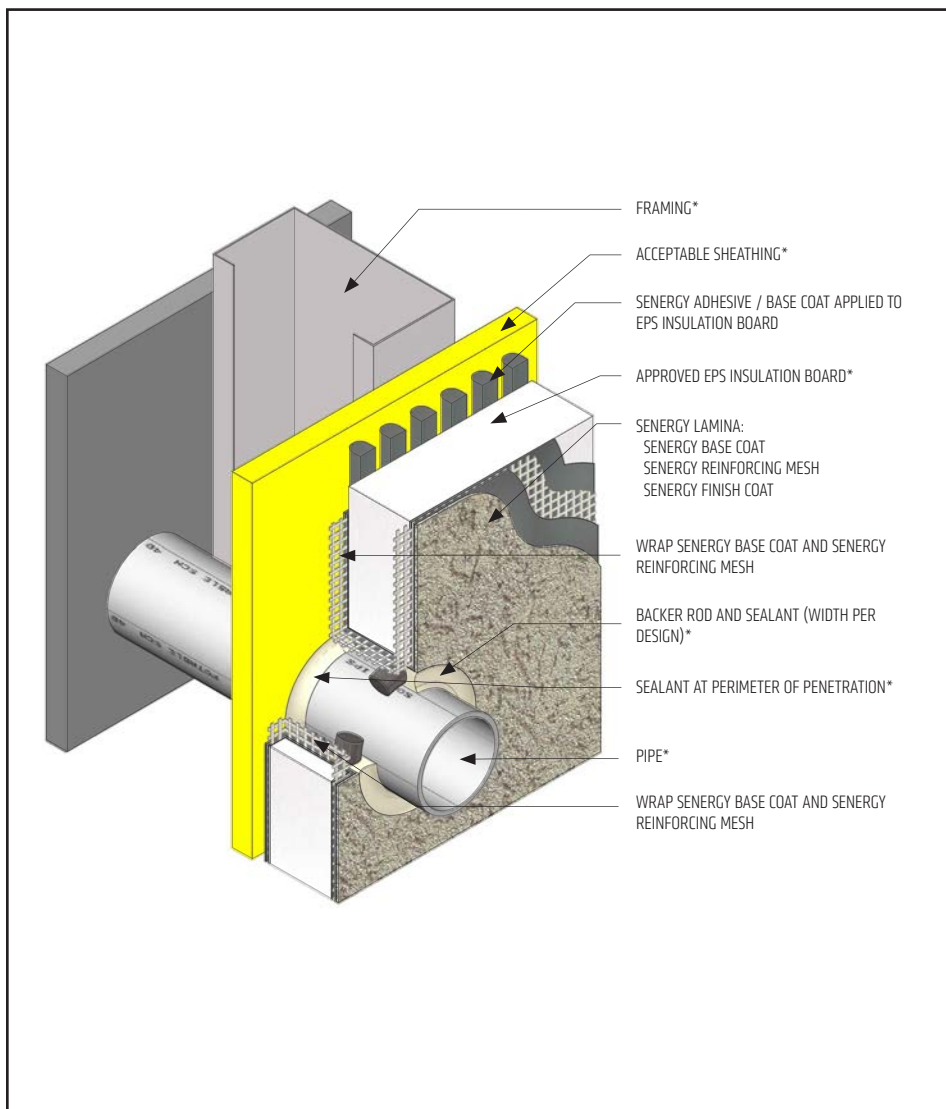

- All terminations must be fully encapsulated with mesh reinforced base coat.
- Do not apply finish to areas that will receive sealant.
- Ensure all penetrations through the system are properly sealed.

PB-16 2401

(*NOTE: BY OTHERS)

The details within are the latest recommendations and are represented in good faith by Sika Corporation US (hereinafter Sika). The details are subject to change without notice. Sika accepts no liability for the end use of the details. For conditions not shown, consult Sika for review of specific details.

- Install Sika materials in accordance with current installation instructions.
- Unsatisfactory conditions shall be reported to the General Contractor and corrected before the application of Sika products.

Senerflex Classic PB

TYPICAL CORNER MESH

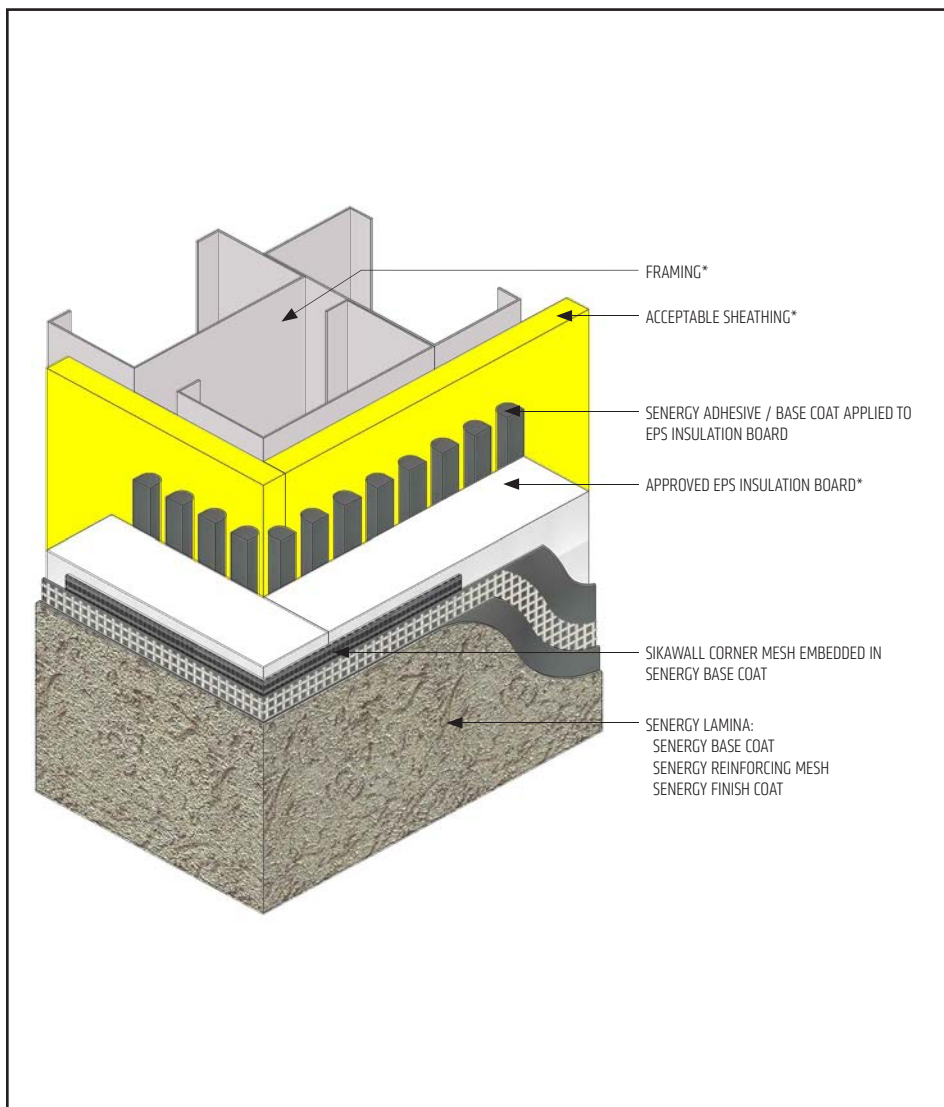

- Ensure reinforcing mesh is continuously lapped a minimum of 8" (203 mm) around corners.
- Stagger vertical joints in EPS insulation board at corners.

PB-17 2401

(*NOTE: BY OTHERS)

The details within are the latest recommendations and are represented in good faith by Sika Corporation US (hereinafter Sika). The details are subject to change without notice. Sika accepts no liability for the end use of the details. For conditions not shown, consult Sika for review of specific details.

- Install Sika materials in accordance with current installation instructions.
- Unsatisfactory conditions shall be reported to the General Contractor and corrected before the application of Sika products.

Senerflex Classic PB

TYPICAL LIGHT FIXTURE

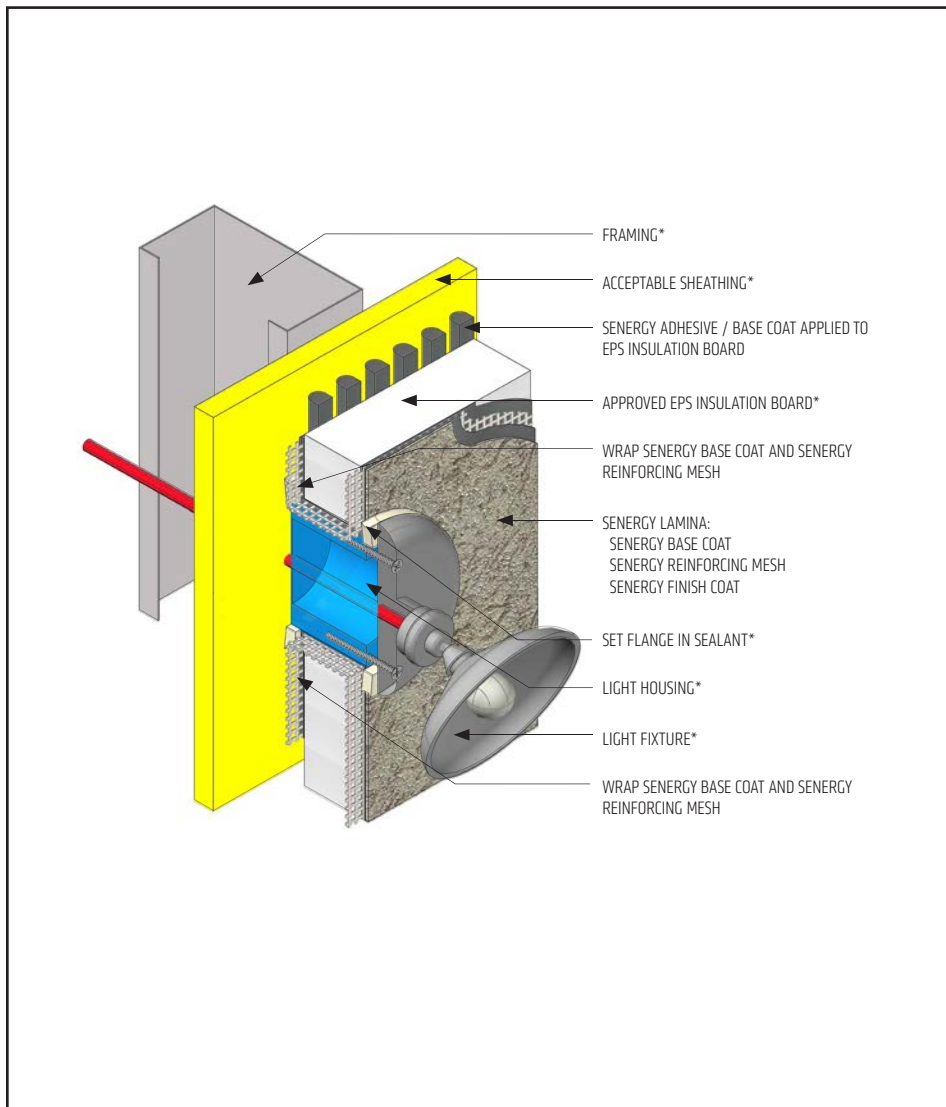

- All terminations must be fully encapsulated with mesh reinforced base coat.
- Ensure all penetrations through the system are properly sealed.

PB-18 2401

(*NOTE: BY OTHERS)

The details within are the latest recommendations and are represented in good faith by Sika Corporation US (hereinafter Sika). The details are subject to change without notice. Sika accepts no liability for the end use of the details. For conditions not shown, consult Sika for review of specific details.

- Install Sika materials in accordance with current installation instructions.
- Unsatisfactory conditions shall be reported to the General Contractor and corrected before the application of Sika products.

Senerflex Classic PB

TYPICAL TERMINATION AT FOUNDATION

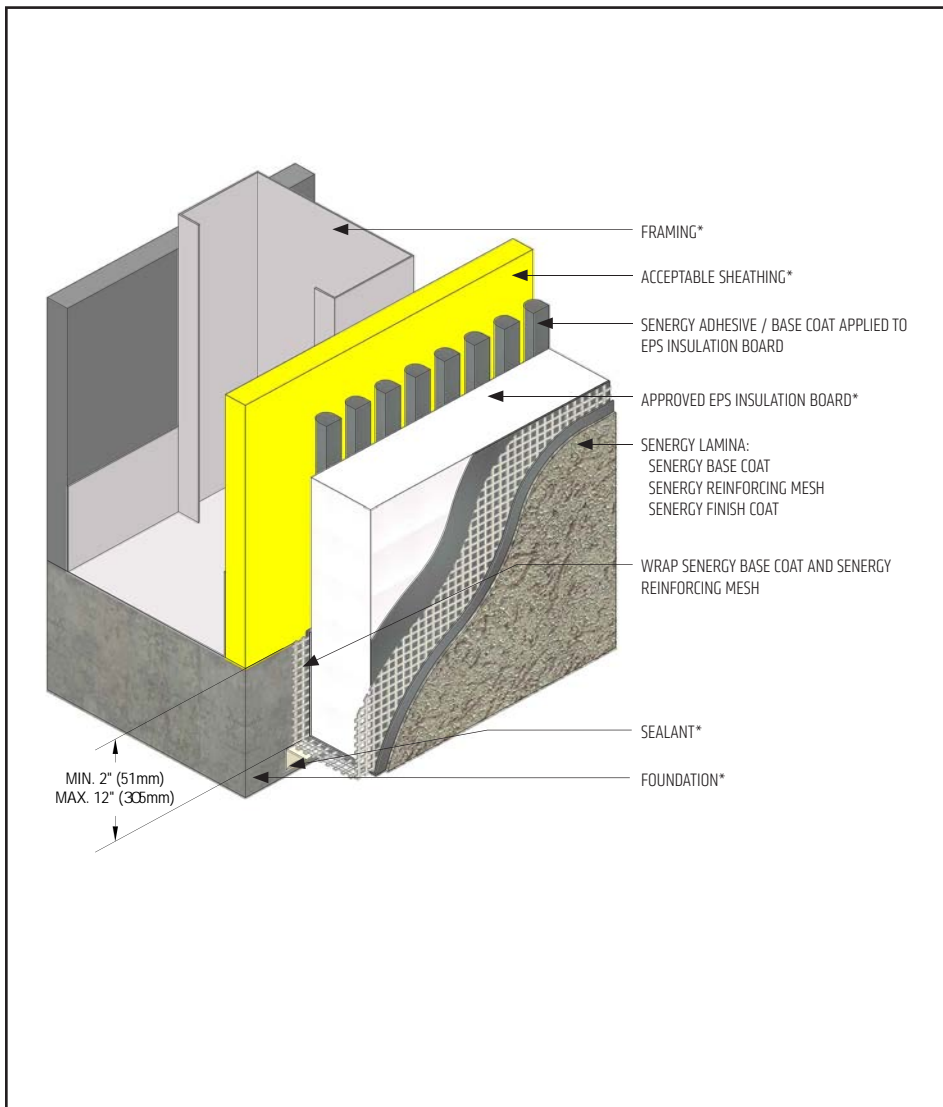

- All terminations must be fully encapsulated with mesh reinforced base coat.
- Terminate system a minimum of 6" (152 mm) above grade.
- Extend system a minimum of 2" (51 mm) and a maximum of 12" (305 mm) at the foundation transition.

PB-19 2401

(*NOTE: BY OTHERS)

The details within are the latest recommendations and are represented in good faith by Sika Corporation US (hereinafter Sika). The details are subject to change without notice. Sika accepts no liability for the end use of the details. For conditions not shown, consult Sika for review of specific details.

- Install Sika materials in accordance with current installation instructions.
- Unsatisfactory conditions shall be reported to the General Contractor and corrected before the application of Sika products.

Senerflex Classic PB

TYPICAL TERMINATION AT FOUNDATION (FLUSH)

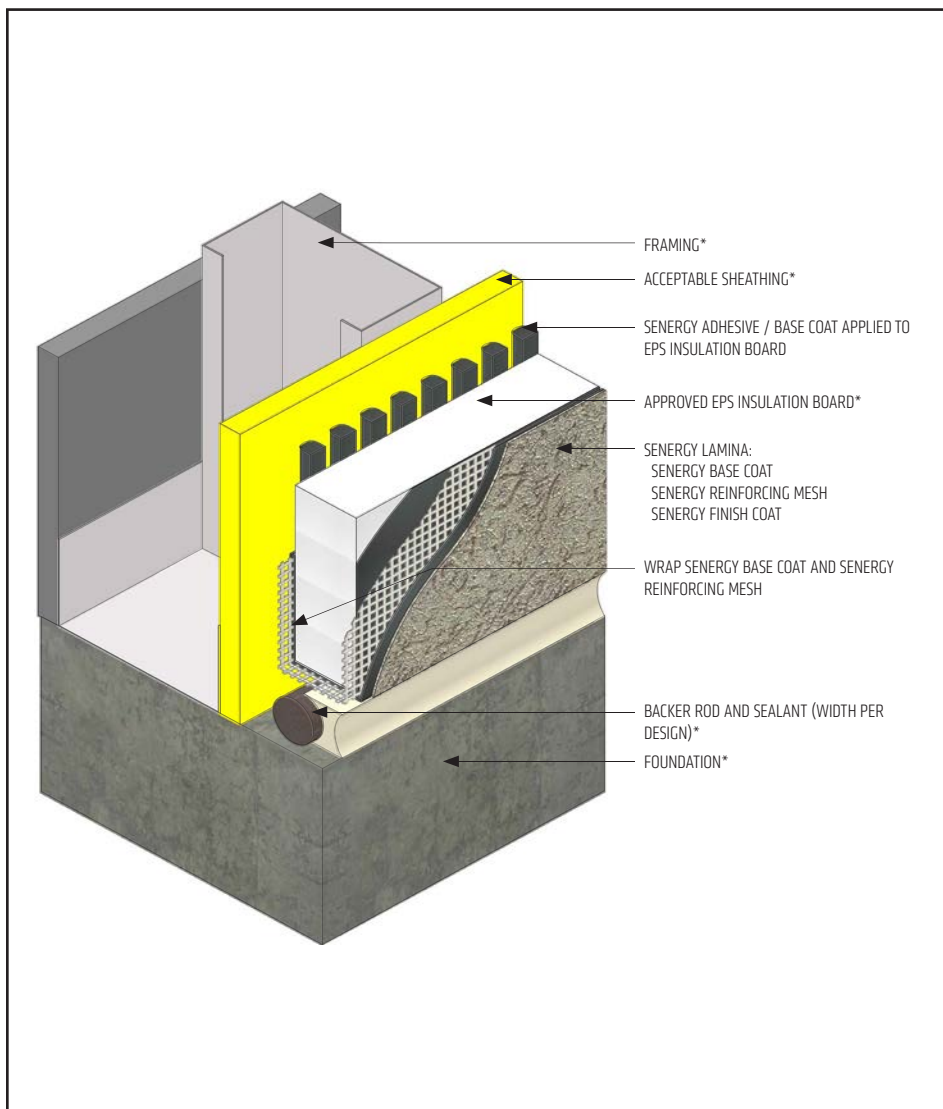

- All terminations must be fully encapsulated with mesh reinforced base coat.
- Do not apply finish to areas that will receive sealant.

PB-20 2401

(*NOTE: BY OTHERS)

The details within are the latest recommendations and are represented in good faith by Sika Corporation US (hereinafter Sika). The details are subject to change without notice. Sika accepts no liability for the end use of the details. For conditions not shown, consult Sika for review of specific details.

- Install Sika materials in accordance with current installation instructions.
- Unsatisfactory conditions shall be reported to the General Contractor and corrected before the application of Sika products.

Senerflex Classic PB

TYPICAL KICK-OUT FLASHING

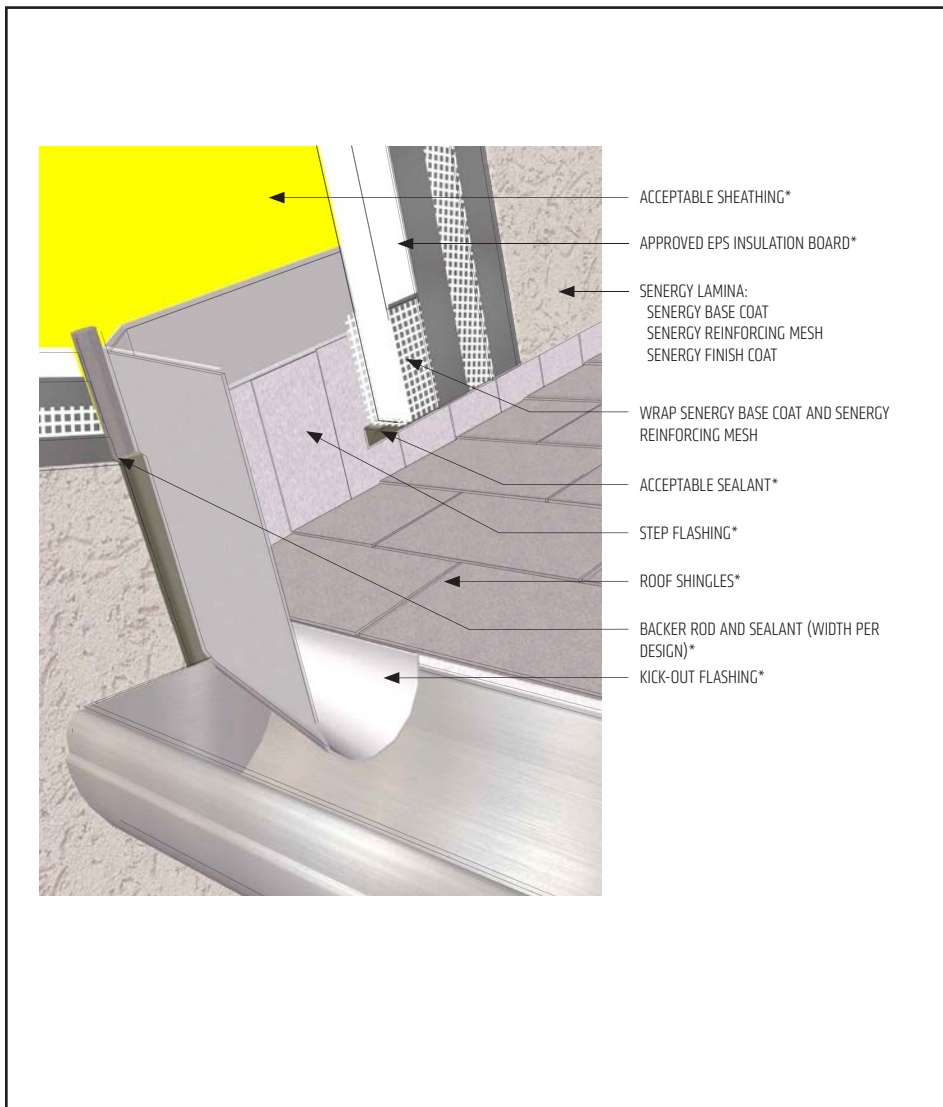

- All terminations must be fully encapsulated with mesh reinforced base coat.
- Do not apply finish to areas that will receive sealant.
- Terminate system a minimum of 2" (51 mm) above sloped roof.
- Ensure step flashing is a minimum of 2" (51 mm) behind system.
- Kick-out flashing shall be a minimum of 4" (102 mm) in height, angled at 100° minimum; seams must be soldered or sealed with appropriate sealant.

PB-21 2401

(*NOTE: BY OTHERS)

The details within are the latest recommendations and are represented in good faith by Sika Corporation US (hereinafter Sika). The details are subject to change without notice. Sika accepts no liability for the end use of the details. For conditions not shown, consult Sika for review of specific details.

- Install Sika materials in accordance with current installation instructions.
- Unsatisfactory conditions shall be reported to the General Contractor and corrected before the application of Sika products.



LIMITED WARRANTY NOTICE

Prior to each use of any product of Sika Corporation, its subsidiaries or affiliates ("SIKA"), the user must always read and follow the warnings and instructions on the product's most current product label, Product Data Sheet and Safety Data Sheet which are available at usa.sika.com/senenergy or by calling our Technical Service Department at +1 (800) 589-1336.

Nothing contained in any SIKA literature or materials relieves the user of the obligation to read and follow the warnings and instructions for each SIKA product as set forth in the current product label, Product Data Sheet and Safety Data Sheet prior to use of the SIKA product.

SIKA warrants this product for one year from date of installation to be free from manufacturing defects and to meet the technical properties on the current Product Data Sheet if used as directed within the product's shelf life. User determines suitability of product for intended use and assumes all risks. User's and/or buyer's sole remedy shall be limited to the purchase price or replacement of this product exclusive of any labor costs. NO OTHER WARRANTIES EXPRESS OR IMPLIED SHALL APPLY INCLUDING ANY WARRANTY OF MERCHANTABILITY OR FITNESS FOR A PARTICULAR PURPOSE. SIKA SHALL NOT BE LIABLE UNDER ANY LEGAL THEORY FOR SPECIAL OR CONSEQUENTIAL DAMAGES. SIKA SHALL NOT BE RESPONSIBLE FOR THE USE OF THIS PRODUCT IN A MANNER TO INFRINGE ON ANY PATENT OR ANY OTHER INTELLECTUAL PROPERTY RIGHTS HELD BY OTHERS. Sale of SIKA products are subject to the Terms and Conditions of Sale which are available at usa.sika.com.

Sika Corporation

201 Polito Avenue
Lyndhurst, NJ 07071 USA
Customer Service +1 (800) 433-9517
Technical Service +1 (800) 589-1336
usa.sika.com/senergy

Rev April 2024

BUILDING TRUST

